



FASCINATING NEW WORKS ON:
ARMS
MILITARY &
POLICE SCIENCE

Copyright © 1968
by
Donald B. McLean

THIRD CLASS MAIL - CORRECT ADDRESS REQUESTED
SEND TO:



GERMAN INFANTRY

WEAPONS

(Vol. 1)

The book you've been waiting for! Declassification of Military Intelligence Service documents permits release of one of the most comprehensive volumes ever compiled on WWII German armament. More than just the usual data with illustrated, detailed coverage of nearly 30 rifles, pistols, submachine guns, light and medium machine guns, anti-tank rifles, grenades and grenade launchers, mines, mortars, light artillery, plus ammo and component markings, firing tables glossary of German terms and abbreviations -- the works! No collector, shooter or professional soldier would be without this 203 page volume. Here's what the reviewers say:

"some of the material...has not, to the best of my knowledge, ever been published before, and thus these books are invaluable for the collector and student of firearms, and for the fellow whose interest centers around military arms. The prices are most reasonable..."

(Bob Steindler in Shooting Times)

"One of the most comprehensive books on WWII German arms ever published."

(Eugene Pitts in Guns)

"German Infantry Weapons runs to about 200 pages and contains virtually all that anyone would ever want to know on the subject, and much more besides. There is an organizational chart of a German Infantry regiment showing the precise equipment of every man and sub-unit, a glossary of German military terms and abbreviations, ammunition charts, and many other fascinating items--even the labels from German ammunition boxes are illustrated. Each weapon is shown with action photos, cut-aways, and detail views, and the very clear text gives everything from operating and maintenance instructions to history and characteristics." (editors of Airfix Magazine)

After the above, what more can we say? Out only two years and already in its 4th printing, and the standard textbook on the standard WWII German weapons. An unbeatable value at only \$3

GERMAN

MG-34

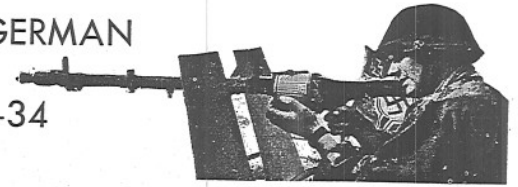

Probably the most important German small arm of WWII, and still in use by many nations, the MG-34 was the standard light and medium machinegun, upon which Nazi infantry tactics were based. A superb and ingenious design (which has been the basis of most post-war machinegun design), the MG-34 was vastly superior to our own Brownings and was to be considered for use by our own troops when captured stocks were available. It was for this purpose our Ordnance Corps wrote the detailed use and repair manual which we have reprinted here in its entirety. With 70 pages and over 60 illustrations, it covers every detail relating to the MG-34 series. All the various magazines, belts, mounts, sights, accessories, ammo and how to use them are given illustrated attention. The most comprehensive book ever in print on the MG-34s. \$2

JAPANESE INFANTRY WEAPONS

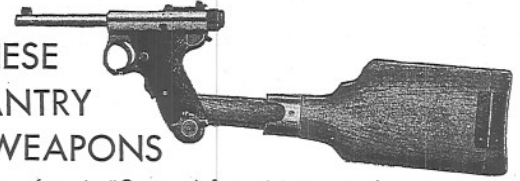

A companion volume to "German Infantry Weapons", this equally fresh and comprehensive book covers in finely illustrated detail the identification, use, maintenance and history of the usual Japanese weapons -- plus the ones you've heard about but haven't seen in print -- plus many you've probably never even heard of! Over 40 different rifles, machineguns, anti-tank rifles, mines, grenades, "knee mortars", everything right up to and including light artillery! A "must" book of 260 pages, "Japanese Infantry Weapons" gives the detailed illustrations and data the collectors have been clamoring for, with most of the information in this volume available no where else. Includes full data on all ammo, even gives candid intelligence evaluation of Jap weapons.

"a long awaited book, very comprehensive, will probably become the standard reference work on Japanese weapons"

(John G. Lawson in GunSport Magazine)

The best book in print on Jap armament, a top value at only \$3.50

.30 CARBINES, M1, M1A1, M2, M3



The standard textbook on the .30 Carbine family. Without a doubt the most comprehensive single volume ever compiled on the US .30 Carbines, models M1, M1A1, M2 and M3. Complete, detailed and fully illustrated coverage of all practical and technical angles such as use, detail disassembly and inspection, full ordnance repair and police full-auto conversion. Handy organization, all parts nomenclature and definition, profuse and clear illustrations.

In its 8th printing, this volume was reviewed in the American Rifleman, Guns, Guns & Hunting and British Publications with such evaluations as "It is the most comprehensive source material I know of for the Carbine..." "a very definite contribution to the now available how-to of the .30 Carbine..." "a new manual covering every aspect of this weapon, 221 pages and 112 figure diagrams...the complete work on the subject."

Every person who owns or is issued a .30 Carbine should have this book. In use by the nation's top law-enforcement agencies and gunsmithing schools -- everything you will ever want to know, about every facet, of every model, of the US GI Carbine family! \$3

GARAND RIFLES, M1, M1C, M1D



For the first time under one cover, detailed and comprehensive attention is given virtually every aspect and accessory of the famous Garand rifles. Slighting no details, this volume gives all pertinent instruction in battlefield use, disassembly and maintenance, right on through all the fully-illustrated details of ordnance repair and complete lock-stock and-barrel rebuilding. Every practical and technical kink a Garand user will need to know, including sniper scopes and mounts, variations, grenades and launchers, ammo, accessories and a complete section on the current 7.62mm NATO conversions.

"Garand Rifles...covers just about everything one would want to know about the Garand rifle..." (Eugene Pitts in Guns Magazine)

A gunsmith's delight, over 160 pages, 175 clear illustrations. Should be on the bookshelf of every Garand owner, and a must book for civil police working with National Guard units. \$3

SPRINGFIELD RIFLES, M1903, M1903A1, M1903A3, M1903A4



The most thorough technical work available on the famous family of M1903 Springfield Rifles. Profusely illustrated, detailed coverage from routine disassembly and maintenance to complete ordnance inspection and repair -- even boresighting, trigger adjustment, sniper scope mounts, accessories and more. Every field and shop angle of the Springfield for the collector, shooter and gunsmith, fully indexed.

"Springfield Rifles, @ \$2.50, covers the Springfield in its many variations...thoroughly" (Eugene Pitts in Guns Magazine)

Over 115 pages, nearly 70 illustrations. If you have a Springfield, you should have this book! \$2.50

M1917 "ENFIELD" RIFLES

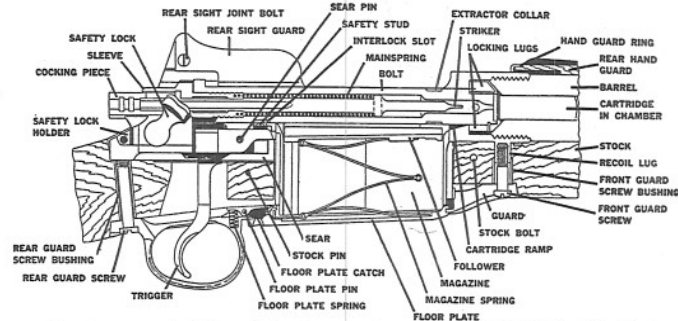

Finally a worthwhile publication on the rugged M1917 "Enfield" rifle! The British design we adopted during the First World War now has become one of the favorites among collectors and shooters. Noted for its ruggedness, the M1917 (and the British P-14 from which it was adapted) is an interesting improvement on the Mauser design, and every part down to the last screw is clearly illustrated in this book, with complete instructions on the use, maintenance and repair -- even data on WWI ammo, firing tables and more. 80 pages, over 160 illustrations, plus charts, tables and diagrams. If you have an M1917 or a P-14, this is a book you need. \$1.50

AR-15, M-16 AND M-16E1 5.56MM RIFLES



A brand new release, with complete coverage of civilian sporter models, and military variations and late developments. Gives specs on such military developments as the Commando Submachine Gun, .223 Heavy Barreled Automatic Rifle, and 40mm grenade launchers. Every facet covered, from use, detail disassembly and inspection to complete repair and maintenance for the various civilian and military models -- the complete story on the controversial M-16 family. Large format, over a hundred pages, hundreds of detailed illustrations. A must book for every AR-15 owner or police and military M-16 user, \$3.50.

THOMPSON SUBMACHINE GUNS



Few arms in history have had the success, and publicity, of the famous Thompson Submachine guns. This new release puts under one cover the most complete compendium of practical and technical Tommy Gun information ever published. Five complete volumes reprinted under one cover, uncut:

- "The Thompson Submachine Gun Model 1928 .45 Calibre" (British)
- "Basic Field Manual Thompson Submachinegun, .45, M1928A1"(US)
- "Ordnance Maintenance, Thompson SMG .45 M1928A1" (US Ordnance)
- "Thompson Submachine Gun .45, M1" (US Army Ordnance)
- "Thompson Ultra Modern Automatic Arms" (Auto-Ordnance catalog)

Over 230 information-packed pages, brimming with exploded view illustrations. No facet of these famous guns left out, from history, commercial models, accessories, to military use and routine maintenance, to complete step by step data on ordnance rebuilding, rebarreling, inspection and testing. No gun library, police armorer, gunsmith or soldier should be without this prodigious volume.

"To my knowledge this is the most exhaustive compendium of information on the Thompson Submachine guns ever printed, and quite reasonably priced too" (John G. Lawson in GunSport Magazine)

Better than five books in one, only \$4

JOHNSON RIFLES AND MACHINEGUNS

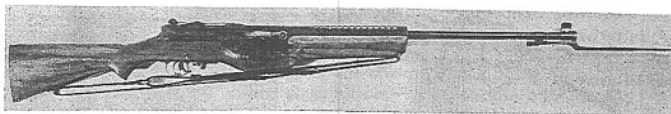

Plowing new ground in a previously neglected field, the story of the only successful recoil operated rifle ever to see combat. Covers history, developmental models, early flight machineguns as issued to the 1st Special Forces and super-spy OSS, rare sporting versions, and the standard military rifle as used by the USMC, Chile and Netherlands. Gives much insight on the development and history of the Johnsons, plus the complete military use and maintenance manuals for the rifle and LMG reprinted in their entirety. With 82 pages and 70 illustrations, this is a book of interest to all firearm enthusiasts, you'll want this even if you don't have a Johnson in your collection. \$2

SUBMACHINE GUNS .45, M3 & M3A1

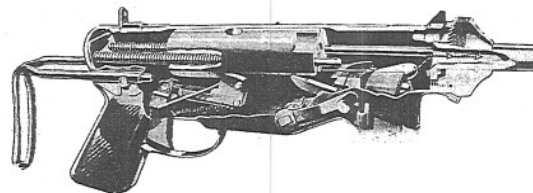

The famous "Greaseguns" of WWII and Korea, second cousin to a Sten and uglier than a mud fence, are given thorough and detailed coverage for the first time under one cover. In two parts, this comprehensive volume gives all angles of use and training, cleaning and maintenance, inspection, repair and rebuilding of the M3 and M3A1 smg's. Over 150 pages, profusely illustrated and clearly presented, this two part volume contains virtually all there is to know about the "Greaseguns", even to the copy in 9mm used by the Viet Cong and illustrations of the silencer they put on it!

"The 'Greasegun' so familiar to many a GI and still in use by many military and police units is a relatively simple arm, but this volume has 150 pages of detail on how to use and repair it. A very complete work of interest to the police and military armorer."

(John G. Lawson in GunSport Magazine)

No arms reference library complete without this one, \$3.

U.S. RIFLES 7.62MM, M-14 & M-14E2



The latest edition, here's the one you National Match shooters and military buffs have been asking for -- all the dope on the new US NATO-caliber rifle. Excellent, profusely illustrated coverage of the use, maintenance and design of the new M-14 and M-14E2 rifles. First-rate illustrations of the improvements over the Garand, a very good guide to use when converting a Garand to 7.62mm and a box magazine. Excellent guidance through the steps of mechanical training, the best handbook available for training police units working with troops armed with M-14 rifles. Large format, 50 pages with 60 clear illustrations, \$2.

REISING SUBMACHINE GUNS



The Stand on the Sling and Hope it Fires Reising, standard issue of the USMC and widely used today among police agencies, is an interesting and cantankerous arm. For the first time information on how to keep these arms in repair and firing order is supplied in illustrated detail. With clear, fresh illustrations the user is guided through use, disassembly and maintenance. Nearly 30 pages, well illustrated. A must book for every individual who owns or uses a Reising, and an interesting dose of nostalgia for every Marine that ever carried one into combat. \$1

.22 SPRINGFIELD RIFLES

Most military powers at one time or another have provided their troops with training rifles in .22 caliber. The US is no exception, and the scarce US .22 Springfield rifles are adequately covered in print for the first time in this book. All three models, the M1922, M1922M1 and M2, were developed in cooperation with the NRA on behalf of the Director of Civilian Marksmanship to promote rifle practice in US schools and colleges. The US Military adopted the same rifles for military training, and all minor variations in the various models used by the military and DCM clubs are shown in illustrated detail. With 53 pages and nearly 70 illustrations, this is not only a guide to identification and use, but a detailed manual covering all pertinent facets of detail disassembly and maintenance. \$2

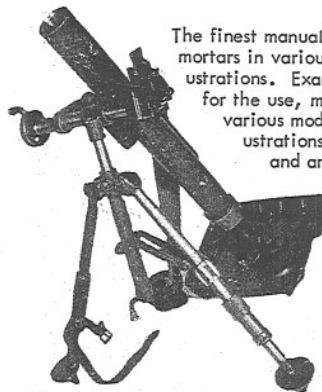

The finest manual in print on the US 60mm, 81mm and 4.2" mortars in various models. Over 270 pages, over 130 illustrations. Exact, comprehensive data and instructions for the use, maintenance and training relative to the various models and calibers of US mortars. Full illustrations of variations in base plates, sights, tubes and ammunition -- plus complete background on all phases of the theory and practice of mortar gunnery. Complete disassembly and detailed parts nomenclature with clear photos. Well indexed. \$3

MORTARS AND MORTAR GUNNERY

MACHINEGUNS AND GUNNERY

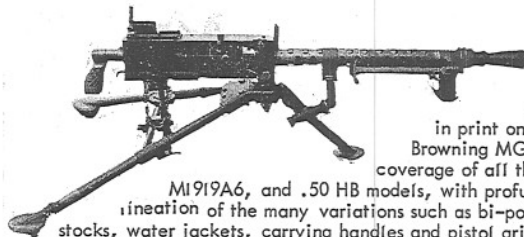

The best U.S. Browning Machine gun book to be had. Probably the most well-rounded volume in print on the US .30 and .50 Browning MG's. Comprehensive coverage of all the various M1917, M1919A6, and .50 HB models, with profusely illustrated delineation of the many variations such as bi-pods, tri-pods, shoulder stocks, water jackets, carrying handles and pistol grips, sights, etc. Complete details of use, disassembly and maintenance, mechanical training, and the theory and practice of gunnery for machineguns. Plus a section on the use and maintenance of the M3A1 SMG. Over 215 pages with nearly 200 clear illustrations, THE BOOK on the US Browning machineguns, \$3.

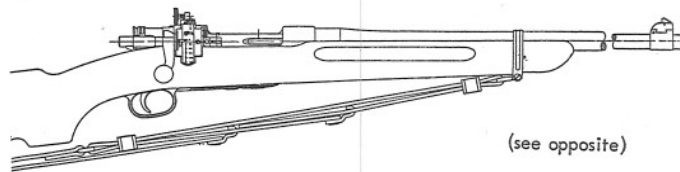

(see opposite)

BROWNING HI-POWER PISTOLS

Originally patented in 1927, the Browning Hi-Power pistol still is one of the finest pistols ever developed. It has been adopted as a military side arm by a dozen different countries, and has been manufactured at various arsenals and plants in a number of military and civilian variations.

For the first time, this new volume thoroughly explores all the facets of these various military and civilian models, from use, disassembly, maintenance and detail repair to history and accessories. With nearly 50 pages and nearly 40 clear illustrations, this volume is undoubtedly the most comprehensive work in print on these pistols. Detailed coverage of such variations as occur in shoulder stocks, sights, lanyard rings, magazines and grips and etc. Instructions on how to take it down to the fast pin for inspection and repair, how to zero it, how to lubricate for combat in special climates -- virtually every aspect of this arm is covered in finely illustrated detail, plus a large fold-out in the rear.

"...the very best job of its type I've ever seen."

(Shelley Braverman in Identification News)

"...complete information on the history, use, maintenance, disassembly and repair..." (Guns & Hunting Magazine)

"This is a well illustrated book showing both the use and maintenance of the gun. A handy book for the Browning owner or any fire arms buff."

(Mike Keesee in Guns & Ammo Magazine)

The best source of Hi-Power information available, \$1.50.

LEWIS MACHINE GUN

The venerable Lewis gun, one of the most noteworthy LMG's of all time, and one of the ancestors of the new M-60 MG.

One of the few weapons to be used in three wars and in a dozen theaters by the US, England, Japan and half a dozen others. This is a quality reprint of the original 1916 handbook put out by Savage, and contains nearly 50 fascinating pages and nearly 30 clear illustrations, plus a large fold out in the rear. Not just pictures of the details of use and disassembly -- but pictures of our dough boys firing from trees, from wood-and-silk, airplanes, motor cycles and the like that will just stay you! No arms library complete without this one! Only \$1.50

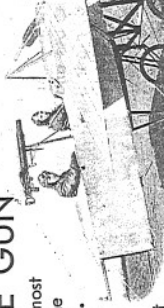

U.S. PISTOLS & REVOLVERS

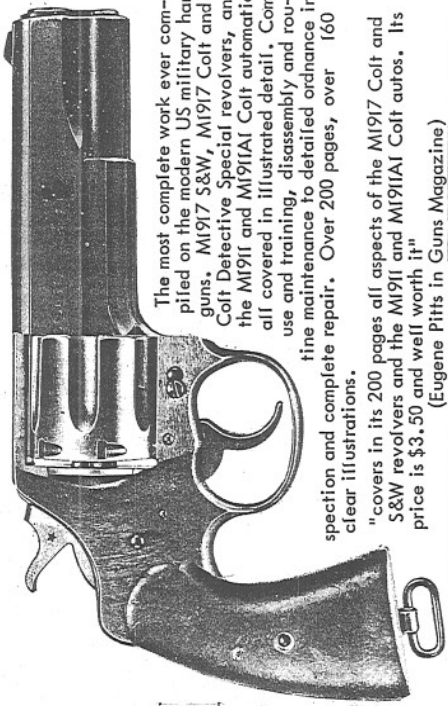

The most complete work ever compiled on the modern US military handguns. M1917 S&W, M1917 Colt and Colt Detective Special revolvers, and the M1911 and M1911A1 Colt automatics, all covered in illustrated detail. Comb use and training, disassembly and routine maintenance to detailed ordinance inspection and complete repair. Over 200 pages, over 160 clear illustrations.

"covers in its 200 pages all aspects of the M1917 Colt and S&W revolvers and the M1911 and M1911A1 Colt autos. Its price is \$3.50 and well worth it!"

(Eugene Pitts in Guns Magazine)

"a rather handy book for owners of Model 1917 Colt and Smith & Wesson revolvers, also Colt Detective special revolver...the manual has illustrated methods of repair, cleaning and disassembly... Worthwhile as both a reference work and as a piece of handgun information."

(Mike Keesee in Guns & Ammo Magazine)

The book police, handgunners and gunsmiths have been asking for, \$3.50

THE "PARABELLUM" (LUGER) PISTOL

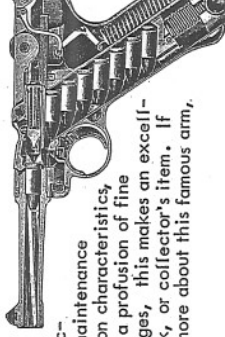

The English version of the official DWM handbook for the famous Luger pistol, giving detailed instructions for the use, disassembly and maintenance of the Luger, with additional data on characteristics, ballistics, etc. With 42 pages and a profusion of fine illustrations including 3 fold out pages, this makes an excellent user's handbook, reference work, or collector's item. If you have a Luger or want to know more about this famous arm, this book is for you. \$1

SHOTGUNS, ALL TYPES

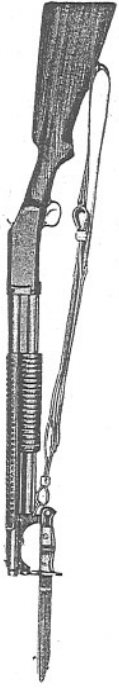

A book every person who ever put together his shotgun and found two springs and a pin left over will find worth five times its price! Two hundred and sixty pages, with 127 clear detailed and exploded-views of eleven different pump and autoloading shotguns by Winchester (M97, M12), Stevens (M520, M620, M620A), Ithaca (M37), Remington (M10, M31, M11, Sportsman) and Savage (M720). The most comprehensive technical work ever published on these repeaters and autoloaders, with step-by-step instructions and detailed pictures showing disassembly, maintenance and special care, cleaning and lubrication, reassembly and ammunition. Special attention given to stoppages and immediate action trouble shooting and repair. Every shotgunner and gunsmith will find this an outstanding bargain, and a must book for police armorers. \$4

FUNDAMENTALS OF SMALL ARMS



The perfect book to cut your teeth on, this rich banquet of information covers just about every topic relating to small arms. No matter how much, or how little, you know, you will find this fascinating reading and one of the most valuable reference works on your shelf. Some of the subjects covered with illustrated detail are: history and development of small arms, small arms ammo, design characteristics, classification of small arms, operating characteristics, hand arms, bayonets and knives, shoulder weapons, rocket launchers, ground machineguns, aircraft armament, truck-boat-ground and tank mounts, signaling equipment, grenade launchers, subcaliber and training equipment, auxiliary equipment, sighting equipment, inspection and testing, plus a complete glossary of small arms terms and a valuable list of references. 236 pages, 188 illustrations, this volume should be the starting point for training any personnel in small arms. Order one for yourself and one for a friend, \$3.50

FIREARM SILENCERS

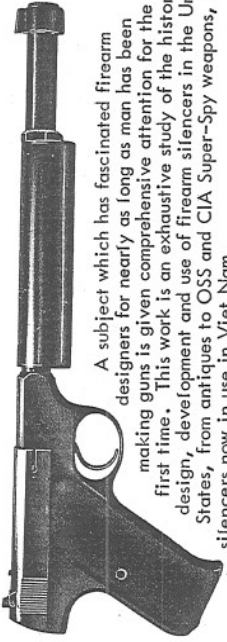

A subject which has fascinated firearm designers for nearly as long as man has been making guns is given comprehensive attention for the first time. This work is an exhaustive study of the history, design, development and use of firearm silencers in the United States, from antiques to OSS and CIA Super-Spy weapons, and silencers now in use in Viet Nam.

With profuse and clear illustrations, this comprehensive volume details the designs of all American inventors, including the famous Maxim and Moore designs. All designs are revealed with over 200 photos and fine drawings, plus patent specifications. Included are double-barreled silencers, oddballs such as combination bayonet-silencers, home made designs, sophisticated silencers which are "tuned" to a particular gun and load, silencers once sold by mail order houses, silencers for pistols, rifles, submachine guns, shotguns, machine guns, even data on how to construct a legal silencer for use on indoor target ranges. As silencer attachments for firearms are illegal, there is even a digest of US and Canadian laws on the subject.

"...not a how-to book, but an exhaustive, objective study, and one of the most fascinating books I've ever read."

(John G. Lawson in GunSport Magazine)

A brand new release, fascinating reading from cover to cover, \$4.

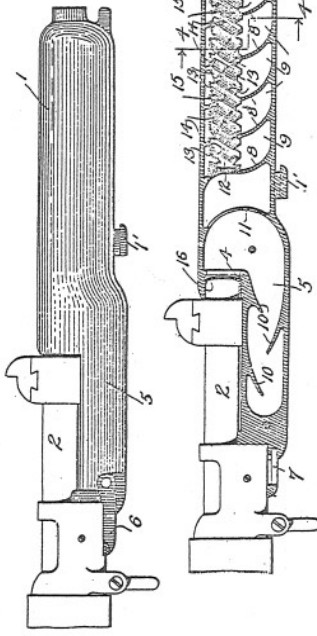

MILITARY & POLICE SCIENCE SECTION

The following works on Military and Police Science are offered only to responsible persons with legitimate interests in these fields, such as: members of the Armed Forces, Armed Force Reserve units, National Guards, State Militias; Federal, State, or Local law enforcement agencies, Sheriffs or Police Reserve Units; students enrolled in ROTC or similar courses of military instruction, students at recognized Military Schools or Academies, collectors of militaria. We reserve the right to reject any order for the following titles solely upon our own discretion.



GUERRILLA WARFARE

A "COLLEGE COURSE" IN GUERRILLA WARFARE

Without a doubt one of the best single-volume handbooks ever written on Guerrilla War. FM 31-21, the "Bible" of our elite Special Forces fighters in its entirety. The most comprehensive, specific, thorough, and intensely interesting volume ever published on this vital subject. With over 250 pages, it gives well illustrated coverage of such topics as organization, logistics, intelligence and counter-intelligence, communications, tactics, resistance elements, security, infiltration, ambush, sniping, patrols, raids, weapons systems, mining, sabotage, offensive and defensive operations, psychological operations, night-airborne-amphibian operations, selection of guerrilla fighters, weapons, demolitions, plus references, glossary of guerrilla terms and a detailed index. An indispensable volume, only \$4.

RANGER TRAINING

FM 21-50, official training manual for the US Army's tough, proven Rangers. Illustrated coverage of such topics as operation against guerrilla action, night operations, raids, ambush and roadblock techniques, cliff assault techniques, intelligence, hand to hand combat, physical conditioning, tactical training, demo, mines, boobytraps, ropes and knots plus a history of the Rangers from Dan Morgan to Colonel Darby. "Ranger training is realistic, rough, and...hazardous..." See why in nearly 230 pages of fascinating reading, a must book for any military library, \$3.50.

IRREGULAR FORCES

FM 31-15, a companion volume to "Guerrilla Warfare", this handbook provides instruction to personnel having the primary mission of eliminating irregular forces. It covers irregular force organization, activities, and tactics; underground organizations; roadblocks, search and seizure, infiltration and community security; harassing operations, denial operations, elimination operations; combat in urban areas; intelligence, censorship, electronic surveillance, interrogation. A very informative and worthwhile work, giving a great deal of insight and practical background for the elimination of irregular forces and undergrounds. The other side of the guerrilla warfare coin, \$1.50.

GUERRILLA WARFARE: A METHOD

SPECIAL WAR Two important works, by a leading Castro in one volume for the first time in the USA. These works are of great professional interest to the non-communist military, and of vital information to all non-communist peoples. In *Guerrilla Warfare: A Method*, Ernesto "Che" Guevara outlines his social basis and tactical reasoning behind the scheduled massive Cuban-type communist guerrilla attack on virtually all American countries. In light of recent reports which indicate Che is not dead as announced in Cuba -- but rather is now in charge of training cadre for the infiltration of guerrillas which has already begun -- Che's revealing plans for the communist guerrilla conquest of the Americas constitute a document we cannot afford to ignore.

In *Special War*, Professor Nguyen Van Hieu, member of the Central Committee of the South Vietnam National Front for Liberation (Viet Cong) gives a prejudiced but nonetheless revealing evaluation of the Special Warfare program of the US Army. The comic book diatribe is to be taken with a grain of salt, but this candid evaluation from the enemy should not be ignored. Both works published in one volume, \$1.50

LEADER'S GUIDE FOR OPERATIONS IN

S.E. ASIA

This concise, valuable work is a resume of the latest techniques and tactics being employed by the US Army in Viet Nam. Describes new ambush and counter-ambush techniques, VC boobytraps as well as many how-to-stay-alive tips. "...read, study, and refer to the guide often. The material it contains may save your life." (Gen. Paul Freeman). 82 pages, well illustrated. \$1.50 (sent to any APO or FPO San Francisco for only 75¢, the perfect gift for your GI buddy in Viet Nam)

ANTI-INFILTRATION & ANTI-GUERRILLA

TRAINING (reprint, Army Subject Schedule 33-11) A brief but comprehensive schedule outlining anti-infiltration and antiguerrilla training programs, with schedule, chart and lesson outlines, instructors notes, training notes and text references, 25¢

MERRILL'S MARAUDERS

Over 120 pages, over 50 photos, maps and charts. Merrill's Marauders, formally known as the 5307th Composite Unit (Provisional), one of the first fast, small, well trained and equipped groups to infiltrate the possibilities of such a javelin strike force which could penetrate enemy lines to wreak defeat and destruction. An important tactical and historical work, outlining how a commando-type force of less than 3000 men was organized, trained and equipped to successfully defeat the veteran soldiers of the Japanese 18th Division in five major and 30 minor engagements, while isolated hundreds of miles behind enemy lines in northern Burma. Fascinating reading for any student of military history, and must reading for small unit commanders, \$2.

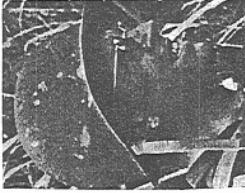

HAND TO HAND COMBAT

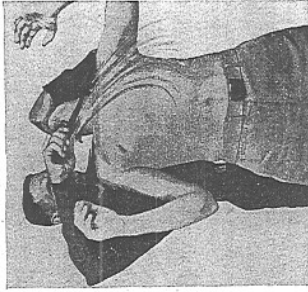

FM 21-150 The finest volume in print on unarmed and knife fighting. Nearly 200 pages, nearly 220 action illustrations covering: fundamentals of hand to hand combat, most vulnerable points (head and neck, trunk, limbs), knife attack, silencing sentries, fall positions and throws (over shoulder throws, basic throws, variations, holds and escapes, disarming methods (bayonet, knife, rifle, pistol), prisoner handling (searching, securing and gagging), advice to instructors, plus references and a fully detailed index. A valuable and significant training handbook for all police and military personnel, and individuals interested in self defense \$3.50

EVASION AND ESCAPE

(FM 21-77) A must book for servicemen in combat areas. Over 170 pages, one of the best handbooks ever written on getting and staying out of enemy hands. Deals in depth with the history of escape and evasion, code of conduct for American soldiers, short range evasion, long range evasion (requirements for success, the will to survive, planning, travel, native assistance), contacting friendly forces, what to expect when captured, what to expect in an enemy POW camp, interrogation (communist methods, resisting interrogation), enemy indoctrination, escape from prisons and POW camps (organizing, escape techniques, escape devices, escape documentation, coverup at roll call), training programs, plus many valuable references and detailed index. One of the most worthwhile books a soldier can have, the information it contains may well save your life. A returning soldier from Florida wrote us:

"A year and a half has gone by since reading a friends copy of "Evasion & Escape" ordered from you. I have since gone to Viet Nam and thank the Good Lord returned. And I must write this book set my mind at ease during that tour of duty." \$3

BAYONET FIGHTING

FM 23-25 all the ins and outs of bayonet offense and defense are covered in 76 pages, with over 70 illustrations covering: uses of the bayonet, principles of bayonet fighting, developing a bayonet fighter, basic positions and movements, long and short thrust series, slashes, smashes and butt strokes, parries and defensive moves, group assault tactics, advice to instructors, setting up bayonet training courses and equipment, group training, coaching and practice. A concise but thorough handbook covering all the various facets of bayonet training and fighting, \$1.50



BOOBYTRAPS

FM 5-31 a treasure trove of information for professional soldier or police demolition specialist, from history to how-to in 180 information-packed pages with 150 detailed illustrations. Expert, revealing coverage of U.S., Japanese, German, British, Soviet, Chinese and Korean boobytrap methods, materials, devices and improvisations. In depth treatment of basic doctrines, employment, safety, boobytrap materials, use of standard ammunition items, improvisations, installation, detection and removal.

Detailed specifics on how to install, detect, and remove boobytraps from buildings, equipment, highways, trails, paths and special areas, which use either manufactured devices or improvised boobytraps making use of every-day materials.

Specific, practical, and undoubtedly the finest non-classified hand book in print on this subject. References, glossary of terms and a detailed index. Fascinating, vital reading from cover to cover. \$3.50

GRENADES AND PYROTECHNICS

FM 23-30 giving detailed coverage of the identification and use of US grenades, fragmentation, concussion, signaling, tear gas and chemical, and rifle launched. Over 220 pg., nearly 70 illustrations. Each type of grenade is explained by characteristics and identification, training and accessories, safety precautions and advice to instructors. All details of use and employment are covered with clear illustrations, and a model training course is outlined. This handbook should be basic training for any police or military personnel who will employ or come into contact with any of the various types of grenades and pyrotechnic signals. \$3.50

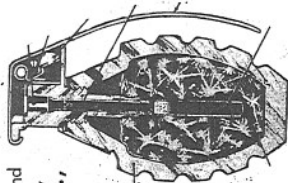

DEMOLITION REFERENCE CARD (GTA 5-14) Handy pocket card describes how to calculate pressure charges, steel cutting charges, shaped charges, concrete breaching charges, and charges for bridge abutment destruction, 50¢, 25¢ with order of other books.

MINE REFERENCE CARD (GTA 5-21) Handy pocket card describes how to lay out a mine field, install and arm anti-tank and anti-personnel mines, camouflage and boobytrap mines, illustrates US mines. 50¢, 25¢ with other books.

EXPLOSIVES AND DEMOLITIONS

(FM 5-25) This comprehensive, practical manual details military, foreign and commercial explosives, safe handling and storage of explosives, demolition equipment and charge firing systems, the calculation and placement of charges for cratering, ditching, land clearing, steel cutting, timber cutting, breaching and pressure charges.

Bridge demolition, advanced demolition projects, destruction of equipment, supplies, buildings and installations; disruption of transportation and communications systems; use of bombs, missiles and shells as demolition charges; summary of demolition formulas. THE BOOK on explosives and demolitions, must reading for ordnancemen and any police bomb squad. 216 pages, well illustrated, \$4.

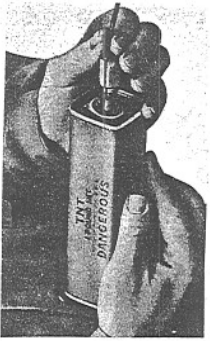

DEMOLITION MATERIALS

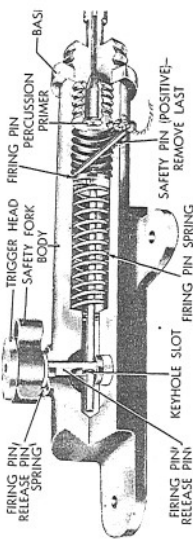
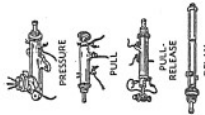

TM 9-1946, a comprehensive catalog of U.S. demolition materials and devices, military and civilian. In depth, illustrated treatment of explosive charges, demolition blocks, shaped charges, cratering charges, dynamites, Bangalore torpedoes, priming and initiating components, detonators, lighters, safety fuse and time blasting fuze, detonating cord, firing devices, percussion primers, blasting caps, tools, accessories, sets and kits, mine clearing devices, safe destruction of explosive devices and materials. An invaluable reference source for the identification of explosive materials and devices, with nearly 100 illustrations, text references, and tables. Of interest to ordnancemen, indispensable to the police explosive or bomb specialist. 166 pages, \$3.50

MILITARY EXPLOSIVES

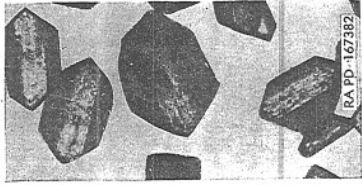

RA PD-167382



RA PD-167402

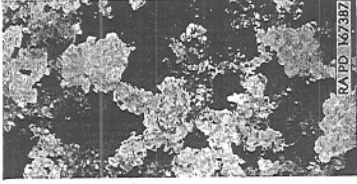

RA PD-167387

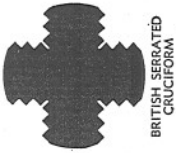
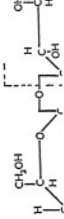

BRITISH SERRATED CRUCIFORM



BRITISH COGWHEEL



GERMAN ROSETTE



JP & JPN

TM 9-1910/TO IIA-1-34, a comprehensive academic treatise, a virtual one-volume detailed encyclopedia on the subject of explosives. Beginning with a basic explanation of the field, this voluminous work goes on to give detailed attention to the following topics: chemistry of explosives and propellants, physics of explosives and propellants, properties and tests of high explosives, black powder, U.S. high explosives, foreign high explosives, properties and tests of propellants, U.S. propellants, foreign propellants, identification of explosive compounds, pyrotechnic compositions, tracer compositions, incendiary compositions for projectiles, packing and marking of explosives, storage and shipment of explosives; disposal, destruction and decontamination of explosives, characteristics and data of explosive and propellant compounds, plus detailed index and an invaluable list of text references. Probably the best source of general and technical information available concerning military explosives, over 350 pages, well illustrated, \$6.

RIOT AND DISASTER CONTROL

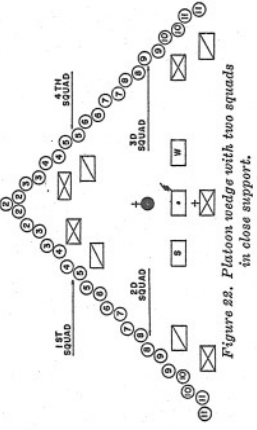

Figure 22. Platoon wedge with two squads in close support.

FM 19-15, regrettably, a most timely and important release. One of the most practical handbooks ever written on the control and suppression of mobs and organized riots. Starting with clear definitions of terms and circumstances, mobs and rioters are examined from a psychological standpoint, and their probable stimuli and courses of action examined. Policies and legal considerations during the use of Federal troops and under Martial Law are examined and explained. A guide for planning, training and operation of Military Forces or Police acting as para-military units in the suppression of civil disorders or riots is outlined, and specific riot control formations are given to meet specific circumstances. Dozens of formations and their applications are clearly illustrated, with the individual function of each part of the unit explained in detail -- from a squad sized operation, to a company massed to protect an installation. Also explained are operations in disaster relief under martial law. With nearly 230 pages, well illustrated, this pocket-sized handbook is an invaluable, practical manual for the training of military troops or civil police units in the art of riot control. \$3

PHYSICAL SECURITY

FM 19-30 A practical handbook for installation and industrial security. Comprehensive coverage of physical security planning, sabotage by fire and/or explosives, nuclear devices and components, sabotage targets, physical protection, perimeter barriers, protective fighting, alarm and communication systems, identification and control, selection-training-employment and supervision of guard forces, storage security, in transit security on highways, marine transport and other media, physical security education, special physical security problems, investigation of breaches in physical security, physical security checklist, identification and disposal of common explosives. A valuable manual for the defense of a city, plant or building against sabotage, unruly mobs, or organized attack. \$2.50, nearly 180 pages, illustrated.

