

# The Wounding of Governor John Connally of Texas

November 22, 1963

By JOHN NICHOLS, MD

*Dr. Nichols is Associate Professor of Pathology in the Department of Pathology and Oncology of the University of Kansas Medical Center, Rainbow Blvd. at 39th St., Kansas City, KS 66103, where he should be contacted for reprint and any other related data. The following article represents the AUTHOR'S VIEWPOINT ALONE, and in no way reflects the views or opinions of the JOURNAL, the Medical and Surgical Faculty of the State of Maryland, the University of Kansas or Gov. Connally.*

## Introduction

The work described herein was done entirely at the personal expense of the author; the findings, ideas, opinions and conclusions do not necessarily reflect endorsement or approval of any other person or organization.



ATTORNEY GENERAL ROBERT F. KENNEDY (left) and PRESIDENT JOHN F. KENNEDY at the White House, 1962. (Photo by Cecil Stoughton, the White House.)

During a fateful six seconds beginning at 12:30 PM (Central Standard Time) in Dallas, TX on Nov. 22, 1963, according to the now renowned Warren Commission Report, Lee Harvey Oswald is alleged to have fired, within 5.6 seconds, three shots—from above, behind and to the right of a motorcade in which then-Texas Governor John Connally was riding 28½ inches directly in front of President John F. Kennedy.

The first bullet is presumed to have entered the neck of the President from behind and emerged at the midline in the front between tracheal rings three and four. Continuing, it entered

AUTHOR'S CORRECTIONS AND ADDITIONS ON GALLEY PROOF WERE NOT FOLLOWED.

the Governor's chest lateral to the right scapula, effecting a fracture of the fifth rib posterior, traversed the thorax right to left and emerged below the right nipple. The bullet continued, fractured the Governor's right wrist and is presumed to have become entangled in his clothing, only later to fall from his trousers on a stretcher at Parkland Hospital, also in Dallas. A fragment of this bullet is considered to have detached and buried itself in the Governor's ~~right~~ femur.

The <sup>left</sup> second shot is considered to have missed, while the third and last shot inflicted the President's fatal head wound. (Figures 1 and 2.)

This paper is a reassessment of Gov. Connally's wounds, taking into account hitherto ignored, but available, facts about his femur wound. From this, I hope, will emerge an awakening to the magnitude of what I consider to be the inadequacy and superficiality in probing the medical aspects of the assassination by the Warren Commission.

After the tragic motorcade shooting, the wounded President and Governor were taken to Parkland Hospital, the nearest fully-equipped, 900-bed teaching hospital, a division of the School of Medicine of the University of Texas; it had a full complement of Professors, Residents, Interns, Nurses and Technicians. As the shocking drama continued that fateful day, every decision and action of the staff and every incident (except that considered herein, in my opinion) has been subsequently subjected to critical scrutiny. Later, in an unauthored article by Parkland Hospital entitled *Three Patients at Parkland*, it was correctly written: "Today . . . Parkland has a new reputation all over the world, and historians are typing its name into manuscripts that will be

During the past ten years this manuscript was rejected by more than thirty medical and scientific journals for various reasons; most were obviously contrived, many were ludicrous, a few were remotely plausible, and six for no reason at all. Despite the rejections the author preferred to not divulge his literary property by the route of the lay or sensational press. This updated manuscript was grossly modified by libel lawyers in Kansas City and Baltimore as well as by the editor. All of the author's additions and corrections to the galley proofs were not followed. Make these changes:

Page 1. Column three, line 15, strike "right" and read "left".  
Page 2. Paragraph two lines 7, 13 and 18 strike "I believe", "I feel" and "I believe."  
After third paragraph insert new paragraph reading: The custody of CE 399 is nebulous. It was found on a stretcher in the hall of Parkland Hospital by Mr. Darrell Tomlinson, an employee of the hospital. It subsequently passed through the custody of at least four persons before being received by the FBI ballistics examiner in Washington. It was not marked for identification and receipts were not given; today Mr. Tomlinson refuses to identify it. Whether the stretcher was used by the President or the Governor is disputed. Some learned counsel opine that CE 399 could not be admitted as evidence in an American (Texas) court, a s i n e

q u a n o n for conviction of Mr. Oswald.  
Page 5. Column three, paragraph 1, strike "m/m" read "mm."  
Page 7. Column three, paragraph 3, strike "I feel." Caption four line 7, strike "author's" and read "author."  
Pages 8-9. Last sentence strike "in my judgment."  
Page 10. Caption for figure seven, line 4, strike "I feel."  
Page 11. Column two, line 16, between "president's neck" and "several" insert "several Governor's chests,".  
Page 12. Column one, paragraph 6, strike "m/m" and read "mm."  
Page 13. Caption thirteen, line 1, strike "Oliver" and read "Olivier".  
Page 15. Column one, paragraph 2, strike "and was again" read "but".

After third paragraph insert new paragraph to read: In an unprecedented letter of August 10, 1977, the Deputy Attorney General, without solicitation, wrote--"You appealed from failure of the FBI to act on your request for records pertaining to an X-ray film of Governor Connally's thigh. [I d i d n o t s o a p p e a l] I have been advised by letter dated March 30, 1977, the Bureau responded to your request. If you are dissatisfied with that action, please advise this office of that fact and we will process this matter as an appeal on its merits." This unsolicited volunteering of action by the Justice Department is in contrast to Mr. Kelley's one year delay in advising that the X-ray film and Doctor Jack Reynolds' report are not in the FBI files. Such action as the Deputy Attorney General volunteered is not provided in the Freedom of Information Act (5 USC 552).  
Page 16. Column one add to paragraph 2.: "Invasion of Governor Connally's privacy is (was) not involved because poor copies of the films were already on deposit in the National Archives and had been published in the volumes of the Warren Commission. This author seems to be the only [medical] person with enough curiosity to examine them. Column one, paragraph four, line 14, strike "by competent radiologists."  
Caption of figure 17, last line strike "in my view."  
Page 17. Column three, paragraph 3, add: My first request, my findings, and my opinions were divulged by Governor Connally at a White House party to President Nixon and to John Sherman Cooper, a member of the now defunct Warren Commission.

Column three, paragraph 4, line 6, strike "I believe." Under Conclusions line 2, strike "the opinion of this author" and read "obvious." Line 12 strike "in my judgment."  
Page 18. Reference 12 strike "m/m" and read "mm."

Add reference: 19. Beale, Betty: Woman's World, Sunday Star, Washington, D.C., April 26, 1970 (p. G2).

in textbooks for generations to come."

This appeared in the January, 1964 issue of the *Texas State Journal of Medicine*,<sup>1</sup> which also reproduced a letter of gratitude from Gov. Connally dated Jan. 8, 1964, together with biographies of the several physicians and surgeons who attended the late President, the Governor and the late Mr. Oswald.

In the course of analyzing and reenacting the assassination of President Kennedy and a study of the Warren Commission documents, an alarming number of previously-unnoticed or ignored errors have been found, ~~I believe~~. Some of these may have had a bearing on the guilt or innocence of the accused, had he been afforded the trial to which he was entitled. This preliminary account of some of the medical aspects brings to light, ~~and~~ details of one of the errors of commission, an error which the late J. Edgar Hoover had on three occasions refused to allow his agents to hear. ~~I believe~~ it bears directly on the validity of the Warren Commission's one-bullet theory to explain the President's neck wound, and *all* of Gov. Connally's injuries.

According to this one-bullet theory, a bullet subsequently designated as *Commission Exhibit (CE) 399* was allegedly fired from the sixth floor of the Texas School Book Depository. It traversed the President's neck from the rear, downward from right to left, and the Governor's chest downward from right to left, fractured the Governor's right wrist and injured his left thigh, only later to fall from his clothing in Parkland Hospital. (Figures 3 and 4.)

Bullet CE 399 weighs 158.6 grains, while unfired bullets from identical ammunition weigh  $161 \pm 0.07$  (standard error of the mean) grains. This leaves 2.4 grains of metal (lead?) to be accounted for. Much speculation and confusion prevails from failure of attempts to make CE 399 fit into the one-bullet theory and to account for all the missing metal.



JOHN B. CONNALLY, former Governor of Texas.

(Pix by Ollie Atkins.)

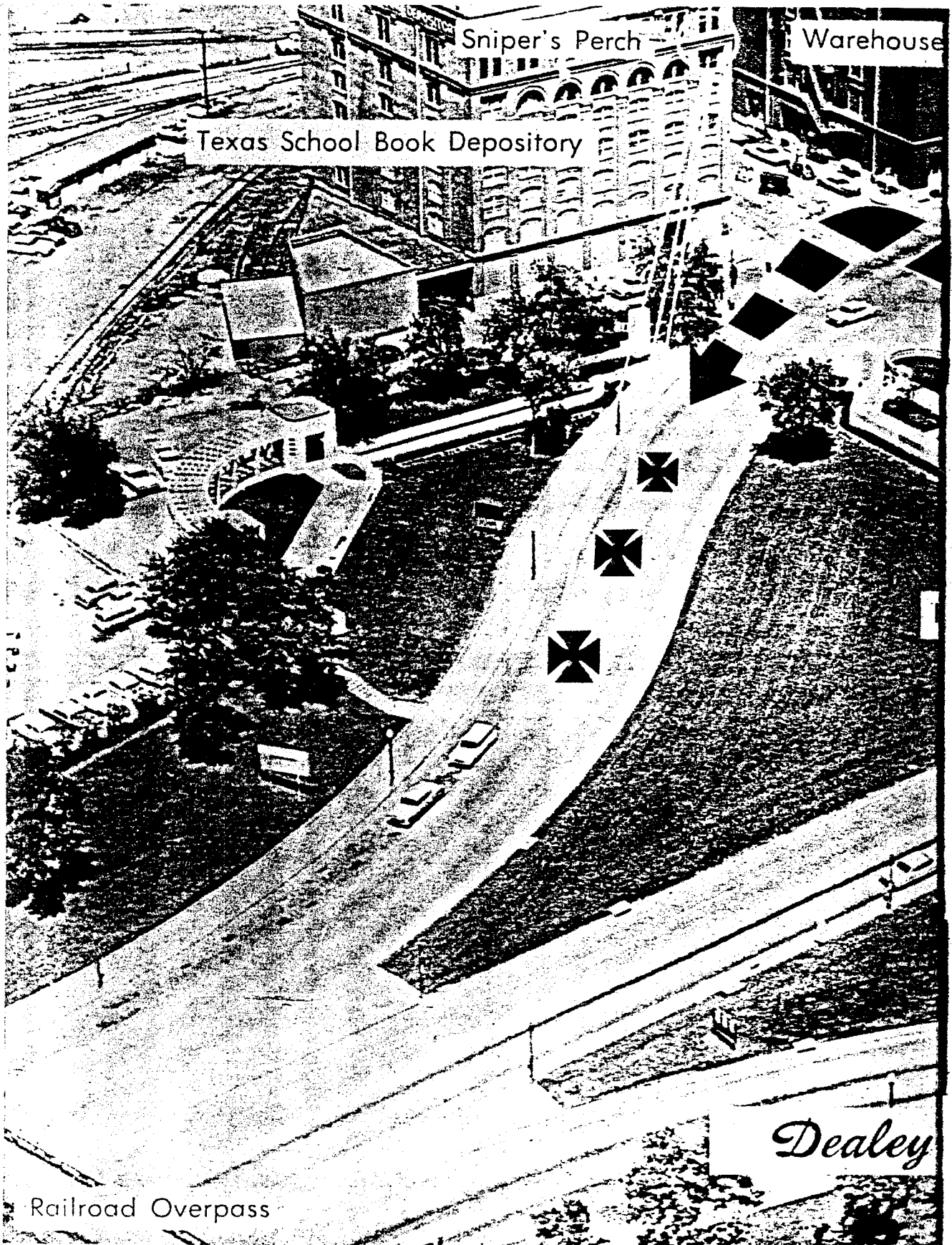

Sniper's Perch

Warehouse

Texas School Book Depository

Railroad Overpass

*Dealey*

FIGURE 1: Postcard view of Dealey Plaza showing route of the motorcade

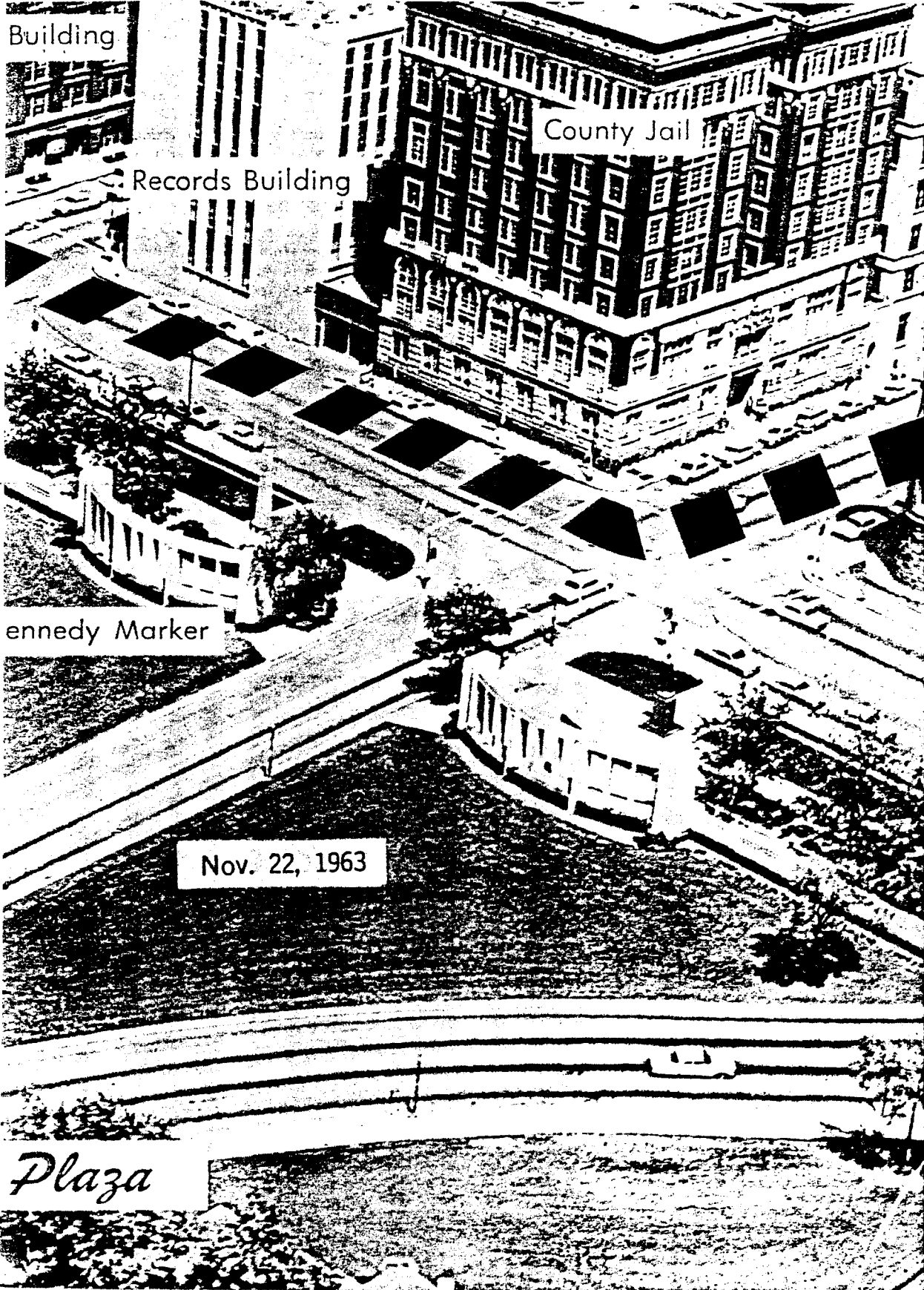

Building

County Jail

Records Building

Kennedy Marker

Nov. 22, 1963

Plaza

alleged firing position of Mr. Oswald and presumed trajectory of the three shots.

According to Commander J. J. Humes, Commander J. Thornton Boswell and Lt. Col Pierre A. Finck—the military medical officers who performed the subsequent autopsy on President Kennedy at the Bethesda Naval Hospital—the bullet which traversed the President's neck did not strike bone or leave metal fragments. These prosecutors did not examine X-ray photographs of the neck at the time of autopsy; however, Commander John H. Ebersole *did so*, and reported this by telephone prior to completion of the autopsy. The prosecutors, together with Dr. Ebersole, subsequently confirmed this absence of fractures and metal particles in the neck of the late President during an inspection of the X-ray films in the National Archives in Wash., DC on Nov. 1, 1966.<sup>2</sup>

An "Expert Review Panel," consisting of Drs. William H. Carnes, Russell S. Fisher, Russell H. Morgan and Alan R. Moritz, with Counsel Bruce Bromley, Esq., was

assembled on Feb. 26-27, 1968, by the US Attorney General, Ramsey Clark, for a study of the X-ray films and photographs taken at the autopsy, but not seen by the prosecutors prior to their autopsy report of Dec. 6, 1963. The existence of the 1968 Expert Review Panel was not made public until Jan. 16, 1969, when a copy of its report (published in full as an appendix to an article<sup>3</sup> by Mr. Blaine Taylor) was deposited with the Washington, DC, District Court. This was part of a futile attempt by Attorney General Clark to forestall issuance of a subpoena requiring the Archivist of the US to take artifacts of the assassination to New Orleans for use in the case of *Louisiana vs. Shaw*. (Mr. Clay Shaw was subsequently acquitted of conspiracy in the assassination of the President.)

The Attorney General's experts in Forensic Pathology and Radiology also agreed that a bullet did not strike bones in the neck, but reported seeing "Several small me-

tallic fragments" in the soft tissues of the neck. This is difficult to understand, because CE 399 is a military bullet with a hard lead core and a full jacket 0.10<sup>m</sup>/<sub>m</sub> thick. It is made of an alloy composed of 90% Copper and 10% Zinc,<sup>4</sup> being approximately the same composition as an American penny. In this writer's experience, identical and similar jacketed bullets do *not* leave metal fragments in soft tissues when bone is *not* struck. Even unjacketed lead bullets usually do not leave metal particles in soft tissues when bone is not struck. A diverse view is taken by Lattimer *et al*,<sup>5</sup> Dr. Lattimer has studied the X-ray films in the National Archives.

These authors believe the metal particles seen by the "Expert Review Panel" are spicules of bone broken from the transverse process of the sixth cervical vertebra after having been struck by the bullet C E 399. They further believe the spinal cord was contused, which would have made serious subsequent complications had the President lived. The spinal cord is among the structures omitted from the autopsy report.<sup>6</sup> It was abridged at the request of Robert F. Kennedy,<sup>3,7</sup> the President's brother, and at that time US Attorney General.

This author has been refused permission to study the X-ray films in the Archives which were taken at autopsy of the late President.<sup>8</sup>

Vice President Nelson A. Rockefeller's *Commission on CIA Activities Within the US* submitted its report<sup>9</sup> in June, 1975, in which it is mentioned that a second panel of experts consisting of Drs. Richard Lindberg, Werner U. Spitz and Fred J. Hodges, together with Lt. Col. R. M. McMeekin and Alfred G. Olivier, VMD, had also studied the X-ray films and photographs taken at the President's autopsy. This autopsy review of the Vice President's Panel is being withheld.<sup>10</sup> White House counsel has advised this author: "These materials from the files of the Commission now belong to the White House, and are under the control of the President. As such, they

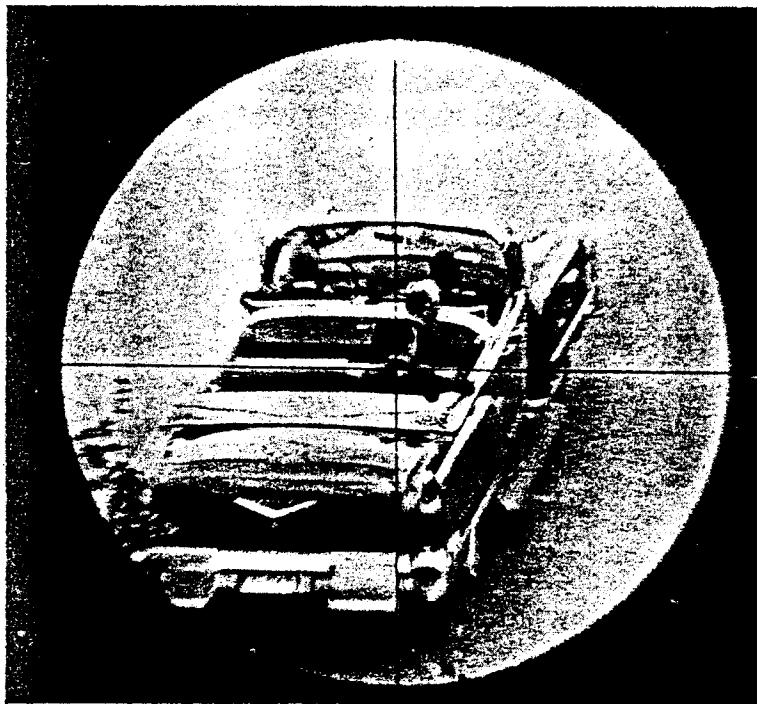

FIGURE 2: View through a telescopic sight at about the alleged time of the first shot inflicting the President's neck wound and the Governor's several injuries. During an FBI reenactment, the lateral firing angle is 9° 21' and the bullet, to emerge in the front between tracheal rings three and four, must strike the vertebral bodies. If it continues in a straight line (not having hit bone), it would hit the Governor in the left chest and emerge below his diaphragm.

are not subject to the Freedom of Information Act, and cannot be made available to you."<sup>11</sup>

Therefore, the alleged bullet CE 399, after striking the President's neck from behind on the right, coursed 20°23' downward and at least 28° to the left, missing the transverse processes disregarding Lattimer et al and emerged in the midline between tracheal rings three and four (Figure 5). Then it is supposed to have entered the Governor's chest lateral to the right scapula, fracture his fifth rib posteriorly, traverse his chest downward, right to left and emerge from the skin between the ribs below the right nipple—all without leaving metal particles!

Note the following dialogue:

*Mr. Specter* (Counsel to the Warren Commission): Was any metallic substance from the bullet left in the thoracic cage as a result of the passage of the bullet through the Governor's body? -

*Dr. Shaw* (Surgeon who operated on the Governor's chest): No. We saw no evidence of any metallic material in the X-ray that we had of the chest, and we found none during the operation. (4 H 105)<sup>12</sup>

### Metal Fragments in Wrist

After emerging from the Governor's chest, CE 399 is then alleged to have struck the Governor's right radius, distally, and to have left three metal particles in the soft tissues (Figure 6). The larger (two) of these particles were removed by Dr. Charles F. Gregory (died March 31, 1976), whose operative report reads, in part, as follows: "Small bits of metal were encountered at various levels throughout the wound and these were, wherever they were, identified and could be picked up, were picked up, and have been submitted to the Pathology Department for identification and examination." (CE 392.)

The results of this examination by the Pathology Department of Parkland Hospital have never been divulged, to my knowledge.

Dr. Gregory subsequently testified before the Warren Commission:

*Mr. Specter*: Are there any other X-rays of the Governor's wrist which would aid the Commission in its understanding of the injuries to the wrist?

*Dr. Gregory*: Only to indicate that there were two fragments of metal retrieved in the course of dealing with this wound surgically, for the subsequent X-rays of the same area after the initial surgery indicate that these fragments are no longer there, and as I stated, I thought I had retrieved two of them—the major one or ones now being missing. The small one related to the bone or most

closely related to bone, and I will put back up here—(sic) (4 H 122).

*Mr. Specter*: What did you do, Dr. Gregory, with the missile fragments which you removed from his wrists? (sic).

*Dr. Gregory*: Those were turned over to the operating room nurse in attendance, with instructions that they should be presented to the appropriate authorities present, probably a member of the Texas Rangers, but that is as far as I went with it myself.

*Mr. Specter*: Dr. Gregory, does that report (CE 392) show the name of the nurse to whom you

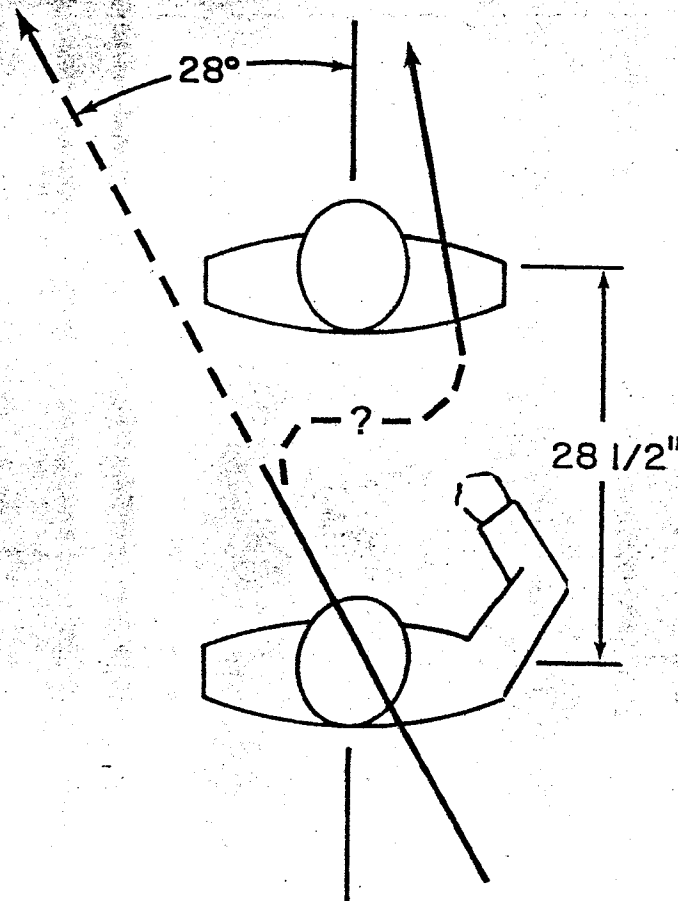

FIGURE 3: (© John Nichols, 1968.) The path a bullet must take if fired at 28° from the left in order to miss the transverse processes of the vertebrae, emerge in the midline and inflict Gov. Connally's injuries. The rear figure represents that of President Kennedy, the forward that of the Governor.

turned over the metallic fragments?

*Dr. Gregory:* There are two nurses who are identified on this page. One is the scrub nurse, Miss Rutherford, and the second is the circulating nurse, Mrs. Schrader.

*Mr. Specter:* And is one or the other the nurse to whom you turned over the metal fragments?

*Dr. Gregory:* I do not now remember precisely to whom I handed them. I do not know (4 H 126).

Written on the "foreign body envelope" of Parkland Hospital (CE 842) is the name of an additional (third) nurse, Miss Bell, who is not mentioned in either Dr. Shaw's operative report on the Governor's chest or in Dr. Thomas Shires' operative report on the Governor's thigh.

The *fragment* (sic) removed from the Governor's wrist next appears captioned "Q9" on a list

(CE 2003) dated Nov. 23, 1963. This list sets forth items obtained from Dallas Police Capt. William Fritz and forwarded that date by FBI Special Agent Vincent Drain to headquarters in Washington. There is no record of the chain of custody of this *fragment* (sic) from Dr. Gregory to Capt. Fritz, nor of its subsequent return to Dallas as stated in CE 2003. Special Agent Frazier stated that the *fragment* (sic) weighed 0.5 grain. It was subsequently assigned Commission Exhibit number 842. Mr. Frazier also testified:

*Mr. Specter:* Would you set forth from the records of the FBI, if you have those before you, the chain of possession of the *fragment* (sic) identified as CE 842, please?

*Mr. Frazier:* CE 842, that is the *one* from Governor Connally's arm, was delivered to me in the FBI laboratory on Nov. 23, 1963 by Special Agent Vincent E. Drain

of the Dallas Office of the FBI, who stated that he secured this item from Capt. Will Fritz of the Dallas Police Department. I do not know where Captain Fritz obtained it. (5 H 72)

Since Dr. Gregory removed the larger (two) of the three metal particles, the one remaining in the Governor's wrist must, indeed, be quite small, I believe.

Figure 7 is the official FBI photograph of the fragment(s) from the Governor's wrist. It must, ~~I feel~~ have been taken after May 6, 1964, when exhibit number 842 was assigned. The holographic notation by Parkland personnel clearly reading "Bullet fragments" (plural), was affixed at the time of removal on November 22, 1963. It is impossible to count the fragments; are there *one* or *five*? This is in violent contrast with Figure 8 from page 147 of Professor Josiah Thompson's book *Six Seconds in Dallas*<sup>13</sup> published

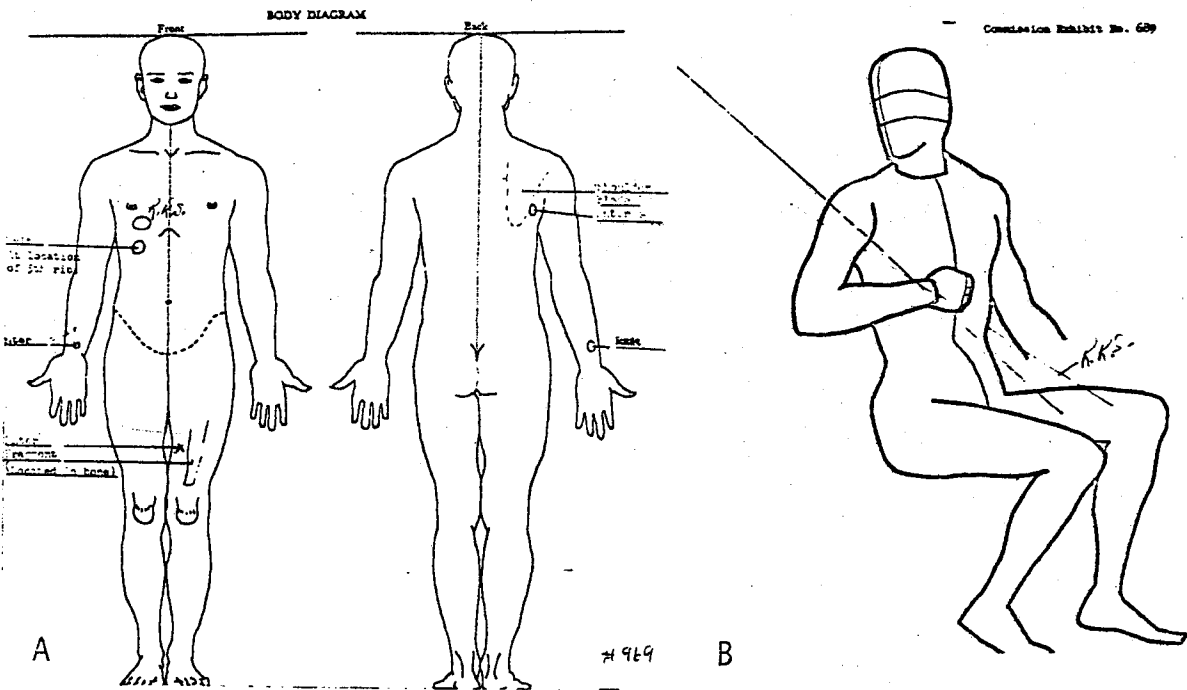

FIGURE 4: Diagrams prepared under the direction of Gov. Connally's physicians intending to show, the author states, in A (CE 679) the location of multiple entrance and exit wounds, as well as the site of the "fragment located in bone" of the left thigh. The initials "R.R.S." are those of Dr. Robert Shaw, who places the exit wound on the anterior chest higher and nearer the right nipple. The drawing B (CE 689) is intended to show the manner in which all three of these wounds arose from the single missile (CE 399) being fired downward at an angle of about 45°. The initials "R.R.S." indicate the trajectory believed by Dr. Shaw (Mr. Oswald's depressed firing angle was 20° 23'). It must be remembered that, from the US Army ballistic measurements and similar ones of the author's, the missile as it emerged from the Governor's wrist and struck his left thigh was moving at about the speed of 1,500 ft. per second.



Jan. 8, 1968, in which two fragments are clearly seen. This photograph, perforce, must have been taken by the Archivist, I believe. Figure 9 is a photograph of CE 842 also taken by the Archivist on July 17, 1968, according to the author's explicit request. The exhibit, at that time, consisted of three fragments. Correspondence with the Archivist on this has been unrewarding; however, Mr. Clarence Kelley, currently FBI Director, on March 5, 1974 wrote that, when received, the specimen was a single fragment.

Since, according to Special Agent Frazier, the larger fragment weighs 0.5 grain, the two smaller fragments *combined* could not, in my opinion, weigh more than an estimated 0.1 grain (photographic comparison and visual inspection of the actual specimens. CE 399 was weighed Dec. 22, 1963, prior to removal of a portion of its nose jacket for spectrographic analysis, a fragment of lead from its base for spectrographic analysis and a fragment of lead at the atomic energy installation in Oak Ridge, TN for neutron activation analysis. The FBI refuses to divulge the amounts removed. A flake of metal fell from the base in January, 1967, while being photographed. The Archivist refuses to weigh CE 399 or its flake, and also refuses to weigh the fragments constituting CE 842. He further refuses to permit this author to weight them.

Allowing a maximum of 0.3 grain loss in firing from friction in the gun barrel,<sup>14</sup> together with the fact that CE 399 lost 2.4 grains, there are still 1.5 grains (97.2 milligrams) of metal to be accounted for. This is about the weight of lead in a number 7 shotgun pellet.

### Ballistics

Shortly after Dr. Gregory removed the metal fragments from the Governor's wrist, Dr. Thomas Shires operated on the Governor's left thigh. (Dr. Shires, a Professor of Surgery, was, at the time of the assassination, attending meetings of the Western Surgical Association in Galveston, TX. After learning of the tragedy, he returned to

Parkland Hospital at 3 PM, examined the Governor's thigh wound and studied the X-ray films, and at 4 PM began his 20-minute operation.) Dr. Shires reports a fragment of bullet still remains embedded in the Governor's left femur.

In order to properly evaluate Governor Connally's thigh wound, some further considerations of CE 399 and its alleged damage are needed, I feel. This bullet, weighing 158.6 grains and forwarded to FBI headquarters on Nov. 23, 1963 under code number "Q1," has

rifling marks compatible with having been fired in Mr. Oswald's alleged Mannlicher-Carcano rifle, serial number C 2766. Figure 10, a photograph of the base of CE 399 taken explicitly for the author by the Archivist, shows the mutilated condition of the base, the extent of which is not generally known. The nose is pristine. The widely-circulated, official FBI photograph omits details of the base. Quite clearly such mutilation would have prevented this bullet from being fired in *any* gun, so the mutilation had to occur *after* being fired, ~~in~~

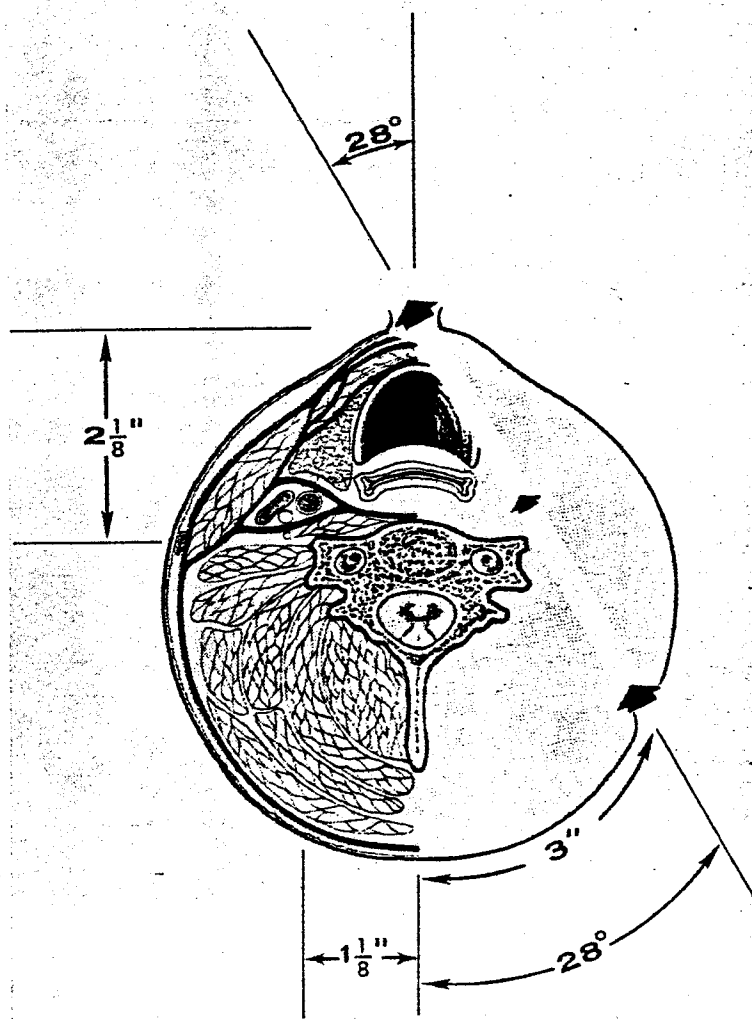

FIGURE 5: (© John Nichols, 1968.) The required path of a bullet through the President's neck to miss the transverse processes and emerge in the midline. The minimum lateral angle to do this is 28°; this is incompatible with Oswald's lateral firing angle of 9°21'. The depressed firing angle is 20°23'.

my judgment

The 1,373 foot-pounds of energy possessed by these 161 grain missiles moving at the speed of 1,960 feet per second is generally not recognized. (Foot-pounds of kinetic energy equals (weight of bullet) times (speed of bullet)<sup>2</sup> over (2 times 32.16) times 7,000 equals 1,373. When: Weight of bullet is 161 grains. Speed of bullet, by chronograph, is 1,960 feet per second at 195 feet, the distance of the [first] neck shot. (2x32.16) is a physical constant relating to the acceleration of a free-falling body. 7,000 grains equals one pound avoirdupois.) US Army ballistic experts found this to be the speed (and energy) of a bullet from authentic ammunition when fired from Oswald's gun at 195 feet, this

being the distance of the first neck shot from the Texas School Book Depository window.

The force and energy of such a bullet may partially be realized in the accompanying Figure 11, where it can be seen to have penetrated 61 pine (*Pinus ponderosa*) boards of heart wood, devoid of knots, for a distance of almost four feet before all of its energy was absorbed. Figure 12 is an X-ray photograph of this bullet before dismantling the laminated block and sawing it sagittally. It can be seen that the bullet is essentially pristine, and no metal tract is present to X-ray examination. The bullet lost 51 milligrams (5/6 grain) of weight; its surface showed many scratches, as if by sharp needles; the lead core was

slightly extruded, but was otherwise normal.

This extent of penetration has also been observed by Lattimer *et al.*,<sup>15</sup> who found that such bullets regularly penetrate, longitudinal to the grain (?), 25" of "Toughest knotty elm wood" (*Ulmus tomasil*). On recovery, the bullets were consistently found to be pristine, but were not weighed before and after firing. He also found that such bullets will penetrate, cross grain, three telephone poles and emerge "Completely undeformed." Telephone poles in the New York area are usually 11-12" in diameter at the base and are creosoted Southern pine (*Pinus rigida*), which has a fiber strength of 8,000 pounds per square inch, while Ponderosa pine has a fiber strength of 6,000 pounds per square inch.<sup>16</sup>

Drs. A.G. Olivier and J.J. Dziedzian, in their official penetration studies, found<sup>17</sup> that meat simulating the President's neck retarded such bullets only 121 feet per second; a goat thorax simulating Governor Connally's chest retarded it only 265 feet per second and a robust cadaver wrist retarded it only 82 feet per second.

About this Dr. Olivier testified:

*Mr. Specter:* What substance did you prepare to simulate that portion (neck) of the President's body?

*Dr. Olivier:* We determined the distance on various people by locating this anatomical region (neck), and using people of various sizes we found that, regardless of general body build, the distance penetrated was around 13½ to 14½ cm. As a consequence, I used gelatin blocks of 20% gelatin cut at 12½ cm. lengths, and also used horsemeat and goatmeat placed in a box so that—this was a little harder to get the exact length, but that varied between 11½ and 14½ cm. of muscle tissue.

*Mr. Specter:* Did that simulate, then, the portion of the President's body through which the bullet is reported to have passed, as closely as you could for your testing purposes?

*Dr. Olivier:* As closely as we



FIGURE 6: A LogEtronic® print of a poor preoperative second generation X-ray film (C E 691) showing Gov. Connally's right wrist wound with three metal fragments.

could for these test purposes, yes.

Mr. Specter: What measurement was obtained as to the entrance velocity of the bullet at the distance of 60 yards which you described?

Dr. Olivier: The striking velocity at an average of three shots was 1,904 feet per second.

Mr. Specter: And what was the average exit velocity on each of the substances used?

Dr. Olivier: For the gelatin, the average exit velocity was 1,779 feet per second; for the horsemeat, the average exit velocity was 1,798 feet per second and for the goatmeat, the average exit velocity was 1,772 feet per second.

Mr. Specter: Are there any other conclusions which you would care to add to those which you have already indicated, resulting from the tests you have heretofore described?

Dr. Olivier: Well, it means that the bullet that passed through the President's neck had lost very little of its wounding potential and was capable of doing a great deal of damage in penetrating. I might mention one thing showing how great its penetrating ability was; that, say, on one of the gelatine shots, it went through a total-counting the gelatine block it went through, plus the backing-up blocks of gelatin—it went through a total of 72½ centimeters (24½ inches) of gelatin, was still traveling and buried itself in a mound of earth, so it has terrific penetrating ability. This means that had the bullet that passed through the President's neck hit in the car or anywhere, you would have seen the evidence—a good deal of evidence.

(For the simulation of Gov. Connally's chest wound, a goat's thorax

was used.)

Mr. Specter: And what distance was utilized?

Dr. Olivier: On the goat the distance was 70 yards.

Mr. Specter: And was there any covering over the goat?

Dr. Olivier: Yes. There was a suit, shirt and undershirt.

Mr. Specter: What was the entrance velocity of the bullet?

Dr. Olivier: Striking velocity of an average of 11 shots was 1,929 feet per second.

Mr. Specter: And what was the exit velocity?

Dr. Olivier: The exit velocity was 1,664 feet per second.

(For the simulation of Gov. Connally's wrist wound, cadaver wrists were used.)

Dr. Olivier: The average striking velocity was 1,858 feet per second (at 70 yards.)

DEKALB COUNTY HOSPITAL

FOREIGN BODY ENVELOPES

DATE: 11/23 TIME: 1600 hrs

NAME: J. Edgar Connally

Commission Exhibit No. 842

FOREIGN BODY: Bullet

AREA FROM WHICH REMOVED: Right arm

DOCTORS: Dr. Gregory

NURSES: Hubert - Schroder - Bell

Handwritten notes: 11/26/63, 25/10/68, 11/2/63, 2/2/64, 59

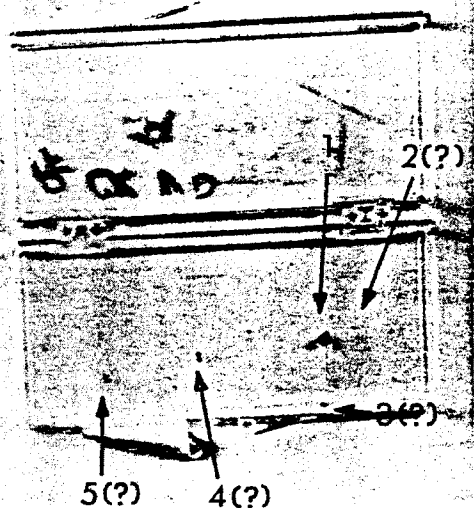

COMMISSION EXHIBIT 842

FIGURE 7: Official FBI photograph of fragments from Gov. Connally's wrist. Note the holographic notation "Bullet fragments" (plural) affixed by Parkland personnel at time of removal on Nov. 22, 1963. FBI Chief Clarence Kelley advises it was a single fragment when received in the FBI laboratory. How many are there now: one or five? The photograph must have been taken, I feel, after May 6, 1964, when exhibit numbers were assigned. The caption for this figure reads "Small fragment of metal from wrist of Gov. Connally."

*Mr. Specter:* What exit velocity did you get on the average?

*Dr. Olivier:* Average exit velocity was 1,776 feet per second.

This was for an average of seven. We did 10. We obtained velocity on seven. (5 H 76 et seq.)

All bullets recovered after firing through cadaver wrists were grossly mutilated in front and pristine at the base, four of which are shown in Figure 13. This is a finding uniformly observed by the author. It will be recalled that CE 399 is pristine in the front and mutilated at the base.

These figures of Dr. Olivier are consistent with those I obtained by chronograph in each of three firings through appropriate anatomical specimens of neck and of wrist at Lake City Army Ordnance Plant in Missouri in March, 1968; however, the retardation of 265 feet per second is about three times that obtained by myself in a single firing through a thorax. I believe such a bullet as CE 399 from authentic ammunition, if fired from Mr. Oswald's gun, would penetrate several Presidents' necks and several Governors' wrists. The upholstery covering

the unarmored partition between the driver and passenger compartments of the limousine was not even scratched; yet, according to the theory set forth by Mr. Arlen Specter and adopted by the Warren Commission, CE 399 became entangled in the Governor's clothing, only to subsequently fall out unobserved on a litter at Parkland Hospital.

### Thigh Wound

This author's interest was aroused quite early by the operative report (Figure 14) of Dr. Shires and his three assistants: Drs. Robert N. McClelland, Charles R. Baxter and Ralph D. Patman.

Their report clearly states that a *bullet fragment was "embedded"* in the Governor's left femur; however, examination of X-ray films published in the Warren Commission Report (CE 695, 696) and on deposit in the National Archives fails to reveal injury to the bone or a foreign body near the bone, as I interpret them. The purpose of their operation was for debridement and removal of the fragment. A metal fragment was not recovered. Dr. Shires subsequently confirmed on several occasions that the fragment remains embedded in the Governor's femur—it did not become an exhibit of the Warren Commission.

Dr. Shires, in his sworn deposition (rules of evidence were observed in testimony taken by the Warren Commission for subsequent possible use in court) taken in Dallas on March 23, 1964, where he had access to the X-ray films, the Governor's clinical chart and his colleagues, testified:

*Mr. Specter:* And what did you observe as to the wound on the thigh?

*Dr. Shires:* The wound on the thigh was a peculiar one. There was a 1-cm. punctate missile wound over the junction of the middle and lower third of the leg and the medial aspect of the thigh. The peculiarity came in that the X-rays of the left leg showed only a very small 1-mm. bullet fragment embedded in the femur of the left leg. Upon exploration of this wound, the other peculiarity

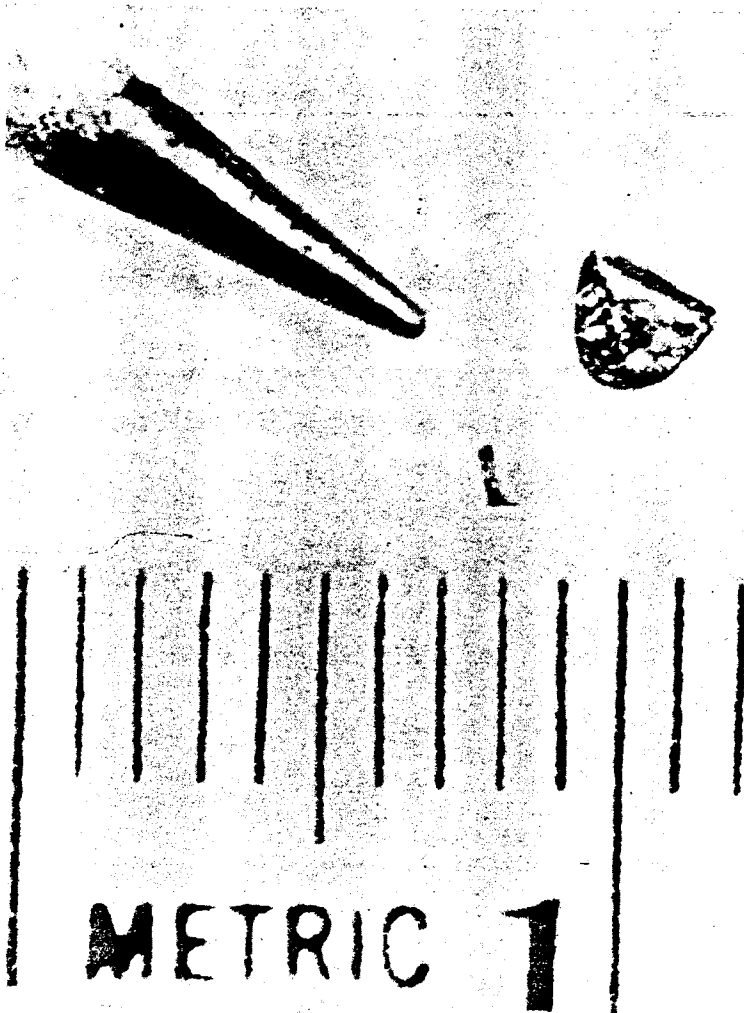

FIGURE 8: (© Josiah Thompson, 1967, [with permission.]) Photograph of CE 842 from Prof. Thompson's book, *Six Seconds in Dallas*. It can clearly be seen that the exhibit at that time consisted of two fragments. This photograph had to have been taken by the National Archivist, I believe.

was that there was very little soft tissue damage, less than one would expect from an entrance wound of a centimeter in diameter, which was seen on the skin. So it appeared, therefore, that the skin wound was either a tangential wound or that a larger fragment had penetrated or stopped in the skin and subsequently fallen out of the entrance wound.

*Mr. Specter:* What size fragment was there in the Governor's leg at that time?

*Dr. Shires:* We recovered none. The small one that was seen on X-ray—and it was still in the femur and being that small, with no tissue damage after debridement—it was thought inadvisable to remove this small fragment.

*Mr. Specter:* Is that fragment in the bone itself at the present time?

*Dr. Shires:* Yes.

*Mr. Specter:* Would you have any estimate as to the size of that fragment?

*Dr. Shires:* One millimeter in diameter—one to two. (Dr. Shires uses the term "diameter," implying that the fragment is spherical. The formula for a sphere is  $\frac{4}{3} \pi r^3$  and lead has a density of 11.4; therefore a 1 mm. sphere weighs 6 milligrams or 1/10 of a grain and a 2 mm. sphere weighs 48 milligrams or  $\frac{3}{4}$  of a grain.

*Mr. Specter:* Would you have any estimate as to how much that might weigh in grains?

*Dr. Shires:* In grains—a fraction of a grain, maybe, a tenth of a grain—very small.

*Mr. Specter:* A tenth of a grain.

*Dr. Shires:* Yes. (6 H 106.)

Prof. Thompson, on page 149 of his book, *Six Seconds in Dallas*, writes: "In a conversation on May 31, 1967, he (Dr. Shires) confirmed to the author (Thompson) that a fragment was indeed embedded in the bone."

Dr. John Lattimer<sup>15</sup> reports that Dr. Shires, on May 6, 1974, again reconfirmed the presence of the metallic fragment embedded in the Governor's left femur.

### X-ray Films

CE 696 is a photograph of a poor copy of a lateral X-ray film of the Governor's left thigh, show-

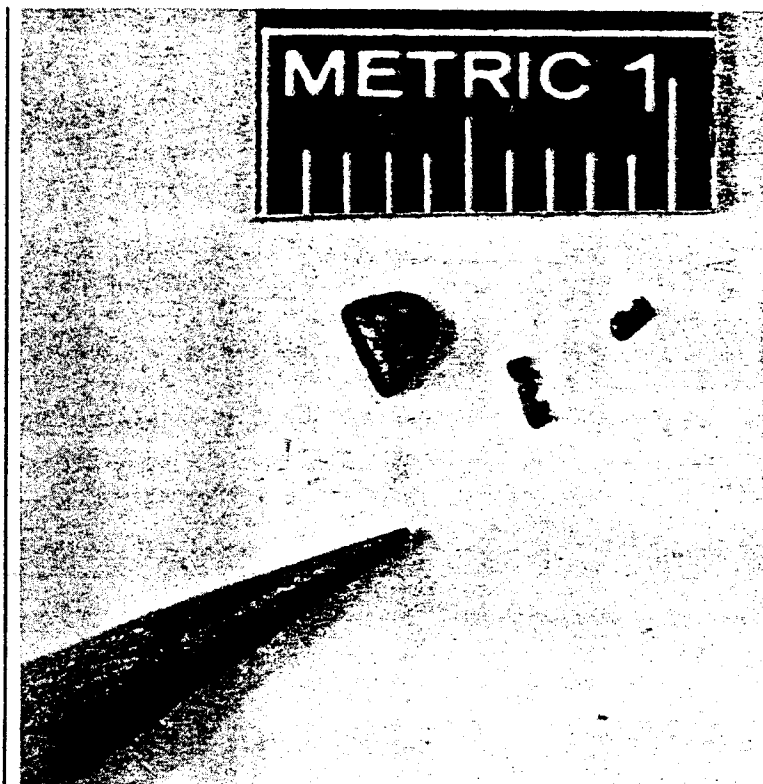

FIGURE 9: (© John Nichols, 1968. A photograph of the (now) three fragments of metal removed from the Governor's wrist, the larger of which weighs  $\frac{1}{2}$  grain (32.4 milligrams CE 842.) Compare with pencil point. Photograph by Archivist on July 17, 1968.

ing an arrow drawn to a foreign body overlying the femur. The femur shows no damage. Two more X-ray films, CE 694 and CE 695, were taken of the Governor's left thigh in the A-P projection. A bullet fragment is *not seen* in either of these films; however, examination of the copies in the National Archives clearly shows a partly-erased arrow drawn to a non-metallic fragment lying subcutaneously on the medial aspect of the thigh. Quite clearly, because there was no bullet fragment, in my view, the four surgeons, led by Dr. Shires, were unable to recover any fragment from the bone in their surgical attempt.

Dr. Gregory opines that operating for such a small bullet fragment is, in any event, questionable surgery unless complications ensue. Certainly Dr. Gregory did not hesitate to leave a metal particle in the Governor's wrist, which was more accessible than the "one" for which Dr. Shires and his three

assistants operated.

About such wounds Dr. Gregory testified: "No effort, incidentally,

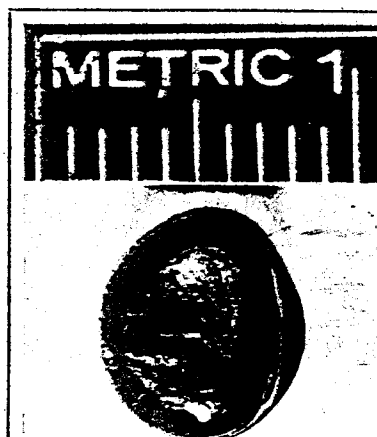

FIGURE 10: (© John Nichols, 1968.) Base of bullet C E 399 showing extensive mutilation, which would prevent it from having been fired in any gun in this condition. This mutilation had to occur after firing; the nose is pristine.

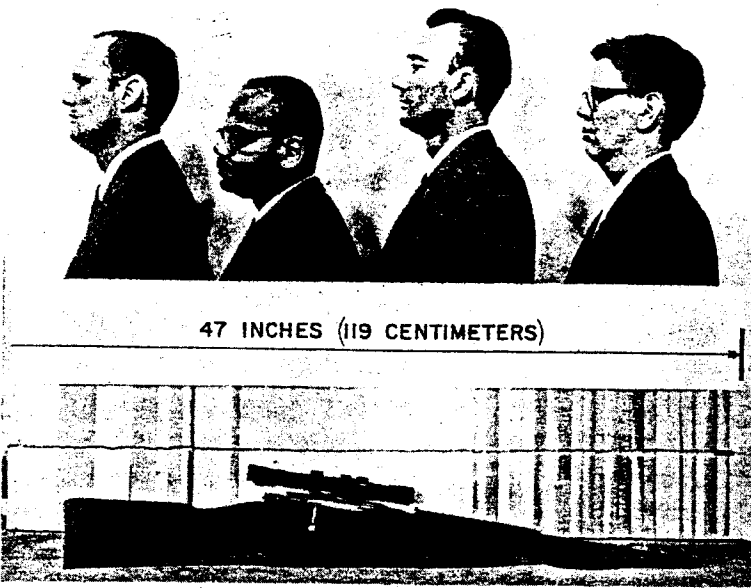

FIGURE 11: (© John Nichols, 1968.) Photograph showing that a bullet from authentic ammunition has enough kinetic energy to penetrate 47" of laminated Ponderosa pine. The first subject has the same measurements as the late President, viz., weight 181 pounds, height 6'1", neck 15½" circumference. The rifle in the foreground is a Mannlicher-Carcano model 91/38, calibre 6.5mm., identical with that attributed to Mr. Oswald.

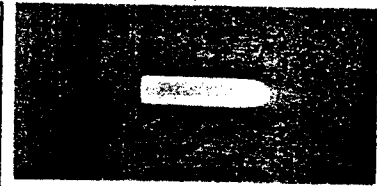

FIGURE 12: Photograph of an X-ray film of the bullet in the block before dismantling the block and sawing each board sagittally for reassembly. The bullet was "pristine," except for many surface scratches, and the lead core somewhat extruded from the rear. The bullet lost 51 milligrams of weight. More than 16 attempts were required to achieve this result; most bullets deviated to the sides, top or bottom, and were not caught.

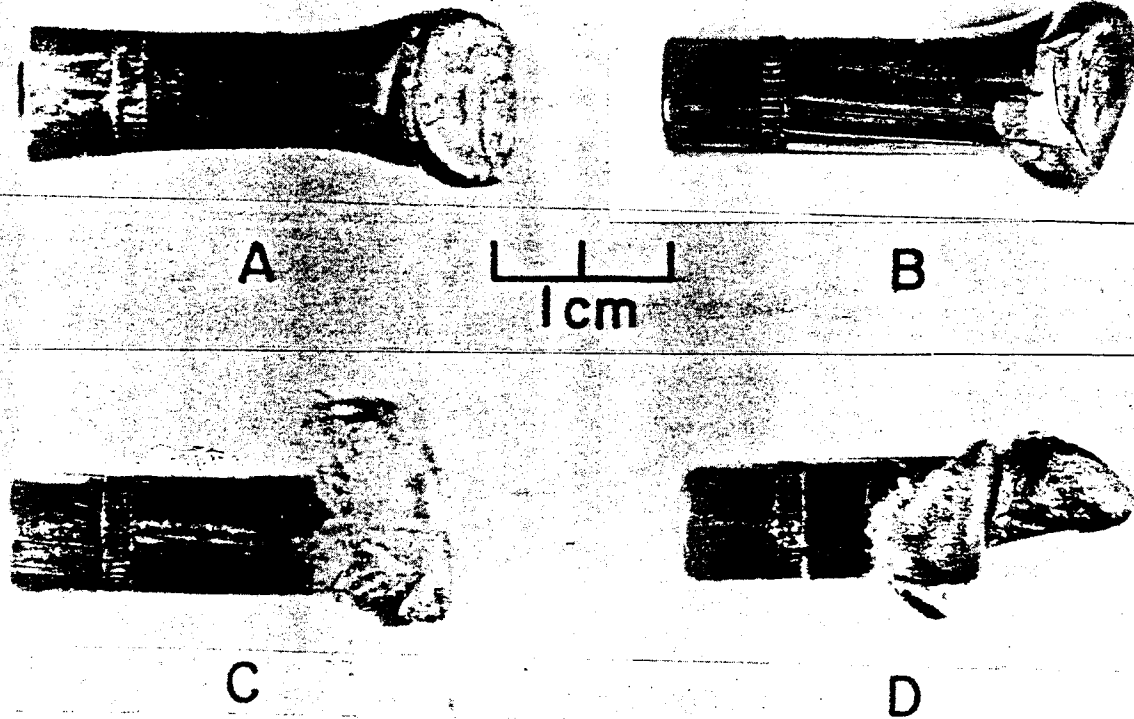

FIGURE 13: Reproduction of Figure A 13 from Oliver and Dziemian's report<sup>17</sup> showing mutilation of the nose of bullets recovered after firing through cadaver wrists. All such bullets caught were similarly mutilated. This is the extent of mutilation also observed by the author after firing bullets from authentic ammunition through cadaver wrists. Bullet B was considered by the Warren Commission and was assigned number 856. (Photographic inset from picture by the Archivist.) Bullets A, C and D were not considered by the Warren Commission and did not acquire C E numbers. (The US Army refuses to photograph A, C and D for the author.)

PARKLAND MEMORIAL HOSPITAL

OPERATIVE RECORD

DATE: Nov. 22, 1963

ROOM: 220 STATUS: Pvt.

NAME: Connally, John

UNIT # 263699  
A #24842

AGE: RACE: W/M

PRE-OPERATIVE DIAGNOSIS: Gunshot Wound, Right Chest, Right Wrist, Left Thigh

POST-OPERATIVE DIAGNOSIS: Same

OPERATION: Exploration and Debridement of (\*See below)

Gunshot Wound of Left Thigh BEGAN: 16:00 ENDED: 16:20

ANESTHETIC: General BEGAN: 13:00 ANESTHESIOLOGIST: Geisecke

SURGEON: Dr. Shires DRAINS:

ASSISTANTS: Drs. McClelland, Baxter and Patman APPLIANCES:

SCRUB NURSE: Oliver CIRC. NURSE: Deming and Schröder CASTS/SPLINTS:

Sponge counts: 1st Correct, PS DRUGS I.V. FLUIDS AND BLOOD  
2nd

COMPLICATIONS: \*This portion of the operation is involved only with the operation on the left thigh. The chest injury has been dictated by Dr. Shaw, the orthopedic injury to the arm by Dr. Gregory.

CONDITION OF PATIENT:

Clinical Evaluation: There was a 1 cm. punctate missile wound over the juncture of the middle and lower third, medial aspect, of the left thigh. X-rays of the thigh and leg revealed a bullet fragment which was imbedded in the body of the femur in the distal third. The leg was prepared with Phisohex and I.O. Prep and was draped in the usual fashion.

Operative Findings: Following this the missile wound was excised and the bullet tract was explored. The missile wound was seen to course through the subcutaneous fat and into the vastus medialis. The necrotic fat and muscle were debrided down to the region of the femur. The direction of the missile wound was judged not to be in the course of

Description of Operation: the femoral vessel, since the wound was distal and anterior to Hunter's canal. Following complete debridement of the wound and irrigation with saline, the wound was felt to be adequately debrided enough so that three simple through-and-through, stainless steel Aloe #28 wire sutures were used encompassing skin, subcutaneous tissue, and muscle fascia on both sides. Following this a sterile dressing was applied. The dorsalis pedis and posterior tibial pulses in both legs were quite good. The thoracic procedure had been completed at this time, the debridement of the compound fracture in the arm was still in progress at the time this soft tissue injury repair was completed.

fs

*Tom Shires, M.D.*  
Tom Shires, M.D.

767

FIGURE 14: Surgical report by Dr. Shires and his assistants, Drs. McClelland, Baxter and Patman, together with Anesthesiologist Geisecke, giving details of the operation on the Governor's left thigh when the sought fragment was not found. (CE 392.)

is made to dissect for these fragments. . . . They are proverbial needles in haystacks, and we know from experience that small flakes of metal of this kind do not ordinarily produce difficulty in the future, but that the extensive dissection required to find them may produce consequences, and so we choose to leave them inside unless we chance upon them, and on this occasion, those bits of metal recovered (by Dr. Gregory from the wrist) were simply found by chance in removing necrotized material." (4 H 123.)

The poor quality films on deposit in the National Archives are copies made by usual photographic processes and, of course, lack the clarity of the originals made on portable equipment at Parkland Hospital. The chain of custody of these films is unclear. At least one copy of a film showing absence of the alleged foreign body in the femur was forwarded to FBI Headquarters by Special Agent Vincent Drain (Figure 15) on Nov. 30, 1963, eight days after the event. The fate of this X-ray plate is nebulous. Early in 1969, I requested permission from the Archivist to examine it and was again advised that it had been returned to the FBI. On Feb. 2, 1976, I again requested permission to examine it and was again advised that it had been returned to the FBI. Application to the FBI in February, 1976 for permission to examine it resulted in a letter, more than a year later, on March 29, 1977, from Director Kelley advising: "Please be informed that a search of the indices to our central records system revealed no information other than what was mentioned in S. A. Drain's report."

On Apr. 5, 1977, the Archivist, without solicitation, wrote: ". . . X-ray film mentioned in Drain's report has never been in the possession of the National Archives and was therefore not 'returned' to the FBI."

In other words, both the X-ray plate and Dr. Jack Reynolds' original report have been lost or destroyed, but the pregnant question remains, Why? Also, why was S. A. Drain's report not considered by

the Warren Commission and given an exhibit number?

In preparation for testimony before the Warren Commission, Dr. Robert Shaw, on Apr. 15, 1964, was requested to bring the Governor's X-ray films to Washington, as was Dr. Gregory, for testimony. These two physicians, presumably, after giving testimony on Apr. 21, 1964, took the films back to Dallas with

them, because on May 19, 1964, the Warren Commission wrote both physicians for copies of the films to which CE numbers had been assigned. On May 29, 1964, Mr. C. J. Price, the Administrator of Parkland Hospital, was thanked for sending the copies which are now in the National Archives. Whether or not the physicians took to Washington any part of the

FD-302 (Rev. 3-3-59)

FEDERAL BUREAU OF INVESTIGATION

Date 11/29/63

1

The following copy of an X-ray negative was received from Mr. JACK REYNOLDS, Administrator, Parkland Hospital, on November 29, 1963, which reflected an X-ray of the left thigh of Governor JOHN S. CONNALLY, which was taken on November 22, 1963.

Dr. JACK REYNOLDS furnished the following letter which accompanied this X-ray negative which is set out as follows:

"SUPPLEMENTARY REPORT DESCRIBING IN DETAIL THE APPEARANCE AND LOCATION OF A SMALL METALLIC DENSITY SUPERIMPOSED ON THE SOFT TISSUE SHADOWS OF THE MEDIAL ASPECT OF THE LEFT THIGH OF GOVERNOR JOHN S. CONNALLY ON FILMS DATED November 22, 1963.

"AP and lateral films of the distal portion of the Mt thigh were obtained and include the distal portion of the shaft and the region of the knee. One film is in the AP projection and the other the lateral projection with the direction of the beam from medial to lateral and the film lying adjacent to the lateral aspect of the thigh.

"No fractures are seen. A few punctate and linear densities are seen on the film but these are inconstant, and appear on one and not the other and therefore are interpreted as artifacts.

"There is, however, one density which remains constant on both films and appears to lie beneath the skin in the region of the subcutaneous fat in the medial aspect of the thigh. By measurements on these films, without correction for target film distance and object film distance, this small density lies 15.2 cms. above the distal end of the medial femoral condyle on the AP film and, on this film, lies 8 cms beneath the external surface of the skin. It is 6.25 cms medial to the femoral shaft. On the lateral film, the center of this small metallic density lies 15 cms above the distal end of the medial femoral condyle. It lies 4.9 cms posterior to the skin of the anterior surface of the thigh and it is superimposed on the shaft of the femur. In relation to the femur, the density is superimposed on a point 1.5 cms posterior to the exterior of the anterior cortex.

on 11/29/63 at Dallas, Texas File # DL 89-43

by Special Agent VINCENT E. DRAIN/atd Date dictated 11/29/63

This document contains neither recommendations nor conclusions of the FBI. It is the property of the FBI and is loaned to your agency; it and its contents are not to be distributed outside your agency.

"The shape of this density is irregular but is roughly oval. Precise measurements are difficult but it is estimated that the greatest length in the AP projection is about 3.5 mms and the greatest width about 1.3 mms.

"Measurements of the density in the lateral projection reveal the greatest length to be about 2 mms. and the greatest width to be about 1.5 mms. The long axis of the metallic object is oriented generally along the axis of the femur."

This copy of an X-ray negative was delivered to the FBI Laboratory on November 30, 1963.

FIGURE 15: Report of FBI Special Agent Drain in which a part of Dr. Jack Reynolds' divergent X-ray interpretation of Gov. Connally's thigh wound was copied. An exhibit number was not assigned.



Governor's clinical chart, including the roentgenographic reports, is not known; at least they did not refer to it.

Starting in early 1965, postal and telephonic requests by this writer for permission to study the original X-ray films at Parkland Hospital were ignored. Unable to reach by telephone any person who would admit knowledge, I was, on several occasions, variously told that the films "Are in the vault," "Are in the Archives in Washington," "The Warren Commission has them," "The Secret Service has them," "The FBI has them," "The Government has them," etc.

Written and telegraphic requests to Mr. Price for permission to study the X-ray films together with the Governor's clinical record were ignored and/or refused, despite the fact that I forwarded Xerox® copies of Gov. Connally's consent (Figure 16), obtained on March 14, 1969.

My last four requests were answered as follows: "Although we are not familiar with the X-ray plates published in the Warren Report, the original X-ray plates are still on file here at Parkland Memorial Hospital. R. G. Holcomb, FACHA, Assistant Administrator, June 27, 1968."

"This will acknowledge receipt of your letter of March 5, 1969, and the attached money order to Mr. R. G. Holcomb, relative to your proposed visit to Dallas to review the clinical record of Gov. John Connally. Mr. Holcomb is no longer with the Hospital District.

"Your American Express Money Order in the amount of \$1 is returned herewith. The Hospital District is obligated to maintain these reports, as well as those of all of our patients in the strictest of confidence, therefore these records are not available.

"A complete statement is included in the Warren Commission Report. Yours very truly, C. J. Price, FACHA, Administrator, March 11, 1969."

"In response to your letter of March 30, 1969, regarding the X-ray plates of Gov. Connally, the

JOHN B. CONNALLY  
FIRST CITY NATIONAL BANK BUILDING  
HOUSTON, TEXAS 77002

March 14, 1969

Dr. John Nichols  
Associate Professor of Pathology  
University of Kansas Medical Center  
Kansas City, Kansas

Dear Dr. Nichols:

In reply to your letter of January 21, 1969 and your wire of March 2, 1969, this is your authority to examine any of the Parkland Hospital records of my injuries.

I do not know what the policy of Parkland Hospital is with respect to these records, but consistent with those policies you have my authorization to review the files involving me.

I am returning the various photographs, exhibits and the money order which you sent me.

I am not unwilling to meet with you personally, but I don't know what I could tell you that would be helpful to you. Basically all that I know I told the Warren Commission report and those records are available to you; but if after reviewing the records of Parkland you think an interview would be productive, we will try to find a mutually agreeable time to do it.

Sincerely,

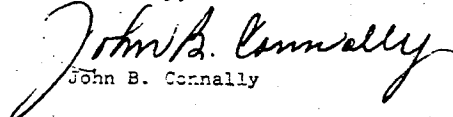
  
John B. Connally

JBC/amt  
Enclosures

**FIGURE 16:** Gov. Connally's permission for this author to study his X-ray films and clinical chart, but which request has been repeatedly denied by Parkland Hospital in Dallas, TX.

plates are not available. C. J. Price, FACHA, Administrator, Apr. 10, 1969."

A Xerox® copy of Gov. Connally's permission (Figure 16), was included in my request of March 30th.

"This will acknowledge receipt of your letter of July 3, 1971, and your check No. 5680 in amount of \$4.50. Your check is hereby returned and we are sorry, but the answer is still no. Very truly yours, C. J. Price, FACHA, Administrator, July 7, 1971."

A second Xerox® copy of Gov. Connally's permission (Figure 16) was included in my request of July 3, 1971.

In preparation for the trial of

*Louisiana vs. Shaw* during the summer of 1969, the prosecution obtained a court order directing the Archivist to take Gov. Connally's X-ray films and other artifacts of the assassination to New Orleans for evidence in the trial. This order was immediately appealed by the Archivist, with the result that efforts were directed to Dr. Robert Shaw to bring the original films from Parkland Hospital from which to testify. About this, Mr. William Alford, Assistant District Attorney, wrote:<sup>18</sup>

"That during the week of Feb. 10-14, 1969, I was in contact with Dr. Robert Shaw, the attending physician of Gov. John Connally in November, 1963. Dr. Shaw had been ordered to appear as a witness in New Orleans in the case

of State of Louisiana vs. Clay L. Shaw, and was attempting to determine what medical records he should bring. I suggested that he bring the X-rays of the Governor, along with the medical record of Parkland Hospital. Dr. Shaw informed me that he had already attempted to locate the X-rays, but had been unsuccessful, as he had been told by Parkland officials that these were in the possession of the US Archivist in Wash., DC.

"I then contacted Mr. Wilson Johnston, an Assistant District Attorney for Dallas County. Mr. Johnston informed me that Parkland officials would require a subpoena *duces tecum* for the medical record of Gov. Connally, and further that the X-rays of the Governor apparently were not in the possession of the hospital.

"Due to the fact that Dr. Shaw's testimony was never required in the Clay L. Shaw trial, no further inquiry was made relative to the location of the X-rays."

In any event, copies of the X-ray films in the National Archives were placed in the public domain when they were published in the volumes of the Warren Commission as CE 681, 682, 691, 692, 693, 694, 695 and 696. Copies of these poor second generation films were prepared specifically for this writer by the LogEtronic® enhancement process at the Armed Forces Institute of Pathology in April, 1968. Examination of the enhanced copy of the lateral film (Figure 17) by competent radiologists confirms the presence of a foreign body to which an arrow has been drawn. It also reveals normal, undamaged bone.

Examination of the A-P projection (Figure 18) again reveals the bone to be without damage and *without any foreign body*; however, on the medial side of the thigh, a faint shadow of a non-metallic foreign body can be seen located *beneath the skin*. An arrow has been drawn to it; the faintness suggests attempts at erasure. In this projection, where the X-ray beam strikes the foreign body without intervention of bone, the shadow is quite faint, and contrasts to the dense shadows cast

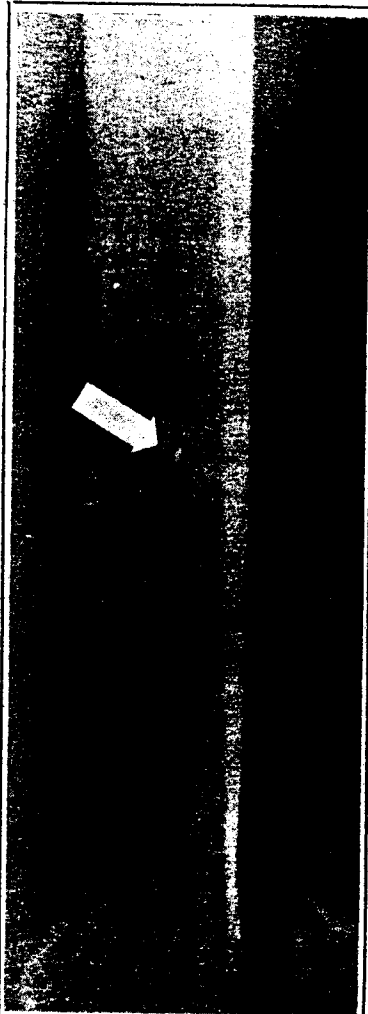

FIGURE 17: A LogEtronic® print of the famous second generation lateral X-ray film (C E 696) alleged to show a bullet fragment "embedded" in the Governor's left femur. Note the absence of bone damage. This photograph is widely utilized to account for the missing metal from C E 399; a feeble attempt which can now be abandoned, ~~in my view~~.

by the heavy metal particles in the Governor's wrist (Figure 6). The object is clearly not heavy metal from a bullet, but, I believe, is something like a fragment of bone (from the wrist), a fragment of glass or of a button, sand, etc.

In most books dealing with the assassination, a photograph of the poor copy of CE 696 is used in an attempt to account for the missing metal from CE 399. Considerable effort in all parts of the world has gone into speculating the weight

of this "bullet fragment." Such activity may now cease, I believe. There have been others who previously questioned the likelihood of a bullet fragment being embedded in the femur. They, like I, asked, "How can a missile, with only enough energy and velocity to merely break the skin, throw off a fragment with enough energy and velocity to penetrate deep through the muscle and embed itself in bone?"

Dr. Jack Reynolds, the Radiologist at Parkland Hospital, held to a different interpretation of CE 696. His supplementary report, copied (at least in part, Figure 15) by Special Agent Drain, not considered by the Warren Commission and now lost, clearly sets out his finding that the foreign body is only 8mm. (1/3 of an inch) under the skin and 6.25 centimeters (2½ inches) medial to the femoral shaft. If the Warren Commission considered this X-ray film, Dr. Reynolds' supplementary report and/or Special Agent Drain's copy, no record exists.

Postoperative X-ray films of the Governor's thigh have never been mentioned. Of course, the whole problem may easily be resolved if the Governor were to have a new X-ray study. During a visit on Apr. 18, 1970, I made such a request which he declined (as he did again in August, 1977.)

A study of the written X-ray diagnoses and of the Governor's clinical chart at Parkland Hospital by independent medical investigators will yield valuable data to seekers of the truth, I believe, such as the newly-created US House of Representatives Select Committee on Assassinations.

### Conclusions

After reviewing the meager available material, it is the opinion of this writer that a bullet fragment is *not* embedded in the left femur of Gov. Connally, contrary to ~~the opinions of~~ one of his attending physicians, his colleagues and Parkland Hospital. Therefore, in regard to this, the conclusions of the Warren Commission are in error and the "one-bullet theory" is further weakened, ~~in my judgment~~. This challenge could have

been avoided if independent medical talent had been utilized by the Warren Commission, and if Parkland Hospital had provided relevant portions of the Governor's clinical chart.

It is feasible to remove the surgically-accessible foreign body present 8mm. under the skin on the medial side of the Governor's left thigh. It could subsequently be identified and compared with the metal in bullet CE 399 by neutron activation.

When one considers studies pertaining to the velocity, energy and penetrating power of authentic ammunition using anatomical specimens and simulations, it is difficult to reconcile these results, in my view, with the conclusions of the Warren Commission regarding performance of CE 399 and its recovery in Parkland Hospital.

#### References

1. Three Patients at Parkland, TX State J. Med., 60:60-74, 1964.
2. Finck, Lt. Col. Pierre A.: Testimony

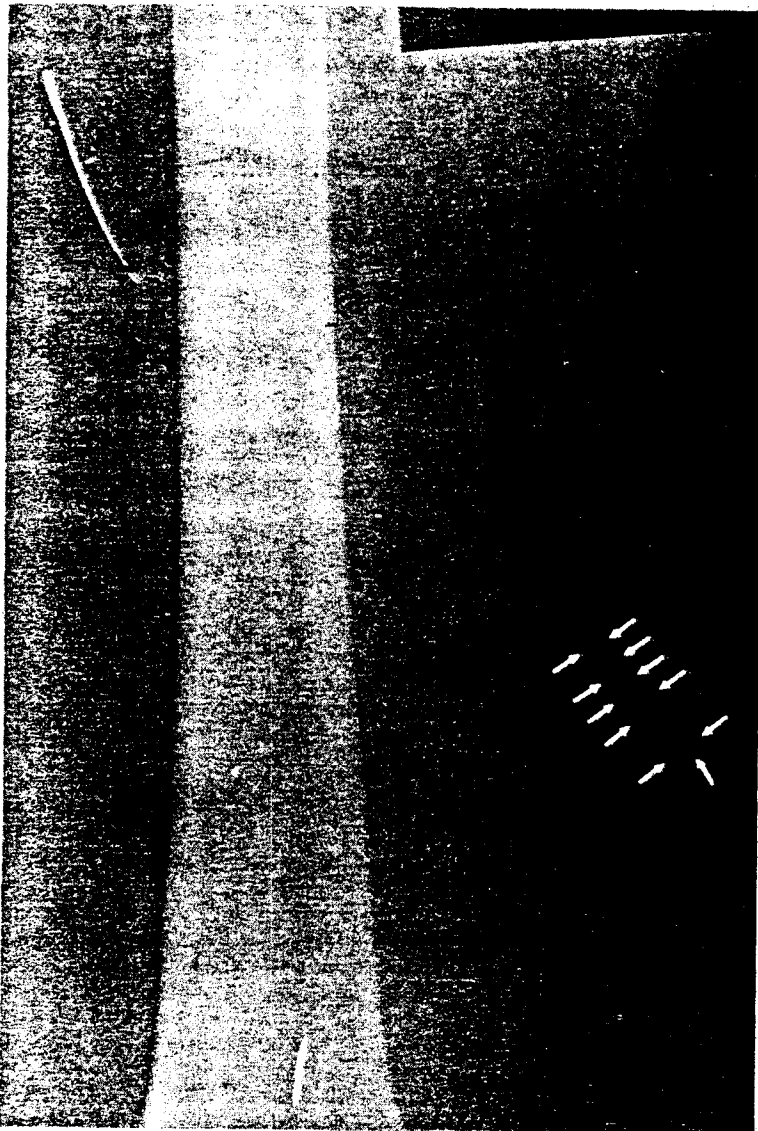

FIGURE 18: LogEtronic® print of a poor second generation X-ray film in the A-P projection of the Governor's left thigh (C E 695), in which a faint "foreign body" can be seen 8 mm. subcutaneous on the medial side as described by Dr. Jack Reynolds. Note the partially-obliterated arrow.

in *Louisiana vs. Shaw*. 198-059; 1426- (30), Section C, Criminal District Court, Parish of Orleans, LA 1969.

3. Taylor, Blaine: The Case of the Out-spoken Medical Examiner or An Exclusive *Journal* Interview with Russell S. Fisher, MD, Chief Medical Examiner of the State of Maryland, Maryland State Med. J., 26:59-77, March, 1977.
4. Winchester® division of Olin® Industries to Nichols, Jan. 17, 1975.
5. Lattimer, John K.; Schlesinger, Edward B. and Merritt, Houston H.: President Kennedy's Spine Hit by First Bullet. Bull. NY Acad. Med., 53:280-291, 1977.
6. Autopsy Report and Supplemental Report (A63-272), Appendix IX, Report of the President's Commission on the Assassination of President John F. Kennedy. US Gov. Printing Office, Wash., DC, 1964, pp. 538-545.
7. Medical Sleuth Deduces Diagnosis in Kennedy. Med. World News, 8:21-22, July, 1967.
8. *Nichols vs. US*, 325 F. Supp. 130, 1971; 460 F 2d 671, 1972; *certorari* denied US 34 L Ed., 2d, 232, 1972.
9. Report to the President by the Commission on CIA Activities Within the US. US Gov. Printing Office, Wash., DC, 1975.
10. Office of the Vice President to Nichols, Sept. 30, 1975.
11. White House to Nichols, Nov. 3, 1975.
12. Prefix = volume; suffix = page number thus, 4 H 105 means Volume 4, page 105, of Hearings Before the President's Commission on the Assassination of President Kennedy. US Gov. Printing Office, Wash., DC, 1964.
13. Thompson, Josiah: Six Seconds in Dallas, Bernard Geis Associates. 1968
14. Nichols, John: Assassination of President Kennedy, Practitioner, 211:625-633, 1973.
15. Lattimer, Gary; Lattimer, John K. and Lattimer, Jon: The Kennedy-Connally One-Bullet Theory. Med. Times, 102:53-56, November, 1974.
16. Southwestern Bell [telephone company] to Nichols, Jan. 8, 1975.
17. Olivier, A.G. and Dziemian, J.J.: Wound Ballistics of 6.5 m/m Mannlicher Carcano Ammunition (U). Chemical Research and Development Laboratories Technical Report 3264, 1965. US Army Edgewood Arsenal. [Declassified March 27, 1973].
18. Alford, William R.: Affidavit of the Assistant District Attorney for the Parish of Orleans, L.A. May 8, 1969, in author's files.

CONFIRMATION COPY PLEASE MAIL TO

DR. JOHN NICHOLS  
8008 REEDS RD  
PRAIRIE VILLAGE KS 62208

RECEIVED  
JOHN NICHOLS  
APR 19 4 43 PM '77  
PATHOLOGY & ONCOLOGY  
UNIV. KANSAS MED. CENTER

02193 N. KANSAS CITY MO 100 04-16 455P CST  
PMS G THOMAS SHIRES M.D., PROFESSOR OF SURGERY REPORT DELIVERED  
CORNELL UNIVERSITY MEDICAL COLLEGE  
1300 YORK AVE NEW YORK CITY NY 10021

FROM MY PRIOR CORRESPONDENCE YOU WILL RECALL THAT I AM WRITING  
ON MEDICAL ASPECTS OF PRESIDENT KENNEDY'S ASSASSINATION  
INCLUDING GOVERNOR CONNALLY'S WOUNDS. WOULD APPRECIATE  
LEARNING IF METAL FRAGMENT REMAINS IN CONNALLY'S LEFT FEMUR.  
MY PREVIOUS INQUIRES TO YOU ON THIS POINT REMAIN UNANSWERED,  
JOHN NICHOLS, M.D. UNIVERSITY KANSAS MEDICAL CENTER,  
KANSAS CITY, KANSAS  
PH 913 NI 2-9460

FIGURE 19: Photograph of telegram, being the author's last futile attempt to obtain details of the "fragment embedded in the femur" from Dr. Shires. The telegram remains unanswered.

VINSON & ELKINS

ATTORNEYS AT LAW

FIRST CITY NATIONAL BANK BUILDING  
HOUSTON, TEXAS 77002

TELEPHONE 713 681-2222 TWX 910284-0228 TELE 782 446

47 CHARLES ST. BENELEY SQUARE  
LONDON W1X 7PB ENGLAND  
TELEPHONE 01-480-7624  
CABLE VINELFINS LONDON W.1. TELE 2340

FORT WORTH NATIONAL BANK BLDG.  
FORT WORTH, TEXAS 76102  
TELEPHONE 817 338-7324

700 PENNSYLVANIA AVE. N.W. SUITE 400  
WASHINGTON, D.C. 20002  
TELEPHONE 202 226-1790  
CABLE VINELFINS TELE 20660

July 26, 1977

Dr. John Nichols  
Associate Professor of Pathology  
The University of Kansas Medical Center  
College of Health Sciences and Hospital  
Rainbow Boulevard at 39th  
Kansas City, Kansas 66103

My dear Dr. Nichols:

I am sure you think I am uncooperative with respect to the article you are writing, but I frankly don't want to go over the galley proofs of your article.

You've done the research; you have your own ideas, and I don't want to be in a position of asking you to change your article, or leave the impression that I have read it and agree with it, if in fact I don't.

I certainly don't want to discourage you from writing whatever you wish about the matter, but I don't want to be in a position of either affirming or objecting to what you do say.

Sincerely,

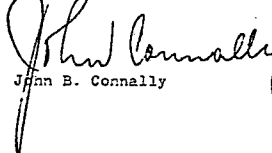

John B. Connally

JBC:ba

FIGURE 20: Author's last communication from Gov. Connally in which he sets forth his reasons for not wanting to review this article in galley form. □